



Weaving Accessories

COMMUNICATION / INNOVATION / COOPERATION

COMPANY PROFILE



Sino Textile

Sino Textile Machinery is specialized in weaving machinery spare parts. With more than 20 years of experience in textile industry, we can deliver textile machinery spare parts meeting the right demand on both quality and price. Under the joint efforts of our members, we have now grown up to be the most integrated supplier in China to offer weaving machines and loom spare parts.

We are providing—

Rapier loom spare parts: including rapier gripper, driving sprocket wheel, gripper opener/releaser, rapier tape, guide hook, guide rail.

Jacquard spare parts: including jacquard wire heddle, spring, comber board, harness cord, harness assembly, pulley wheel, module/solenoid, cable, controller.

Common replacement parts: including weft feeder/accumulator and the relevant parts, weft sensor, electronic weft selector, drop wire, leno selvedge device, heald wire, warp stop motion, tuck in device, cutter and blade, temple cylinder, proximity switch and sensor, circuit panel, electromagnet coil, encoder and motor, heald frame, membrane switch and touch screen, weft feeler, warp beam, clutch and brake, weaving reed and etc.

Dobby spare parts: for Staubli dobbie and Chinese brand dobbie.

According to brand, we are offering parts for: Picanol, Vamatex, Sulzer, Chinese loom, Somet, Dornier, Iro & Roj, Itema, Muller, Panter, Toyota, Tsudakoma, Van De Wiele, Bonas, Gross, Staubli and etc.

Add: No.9, 10th Street, HEDA,
Hangzhou, Zhejiang, China

Mob: 86-18058173515

Mail: merlin@sintextilemachinery.com

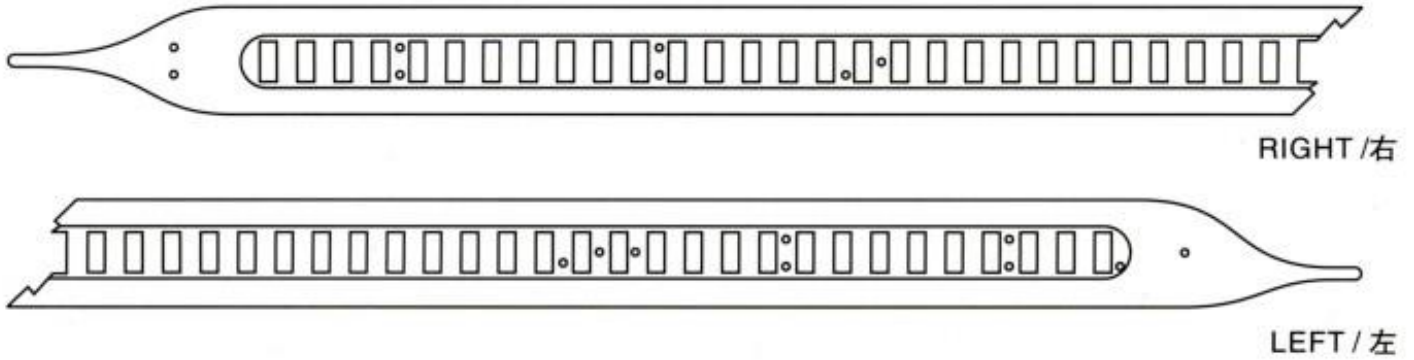

AC2S/TP1

RIGHT / 右		
Loom width 织机幅宽	Tape length 剑带长度	WJT Code WJT编号
210	1900	101 1900
330	2450	101 2450
380	2700	101 2700
420	3100	101 3100
460	3400	101 3400

LEFT / 左		
Loom width 织机幅宽	Tape length 剑带长度	WJT Code WJT编号
210	1900	102 1900
330	2450	102 2450
380	2700	102 2700
420	3100	102 3100
460	3400	102 3400

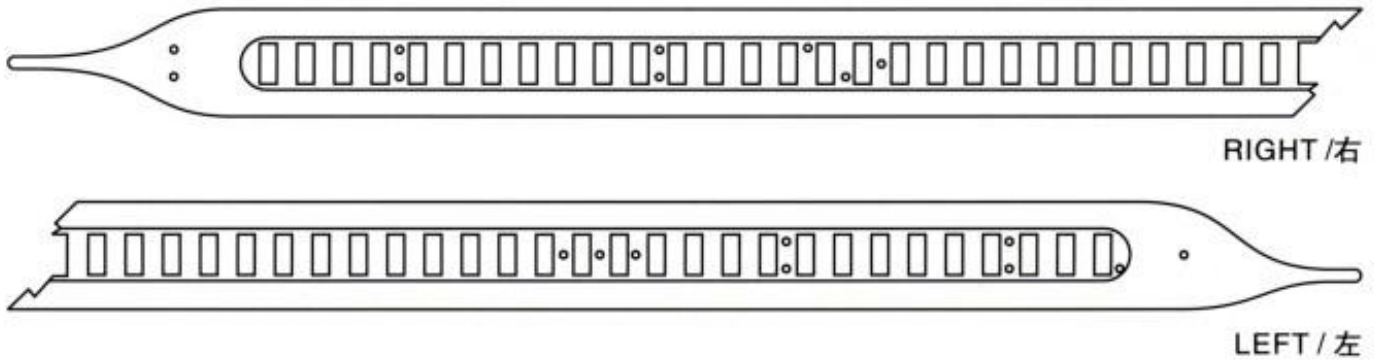

AC2S/TP2

RIGHT / 右		
Loom width 织机幅宽	Tape length 剑带长度	WJT Code WJT编号
210	1900	103 1900
330	2450	103 2450
380	2700	103 2700
420	3100	103 3100
460	3400	103 3400

LEFT / 左		
Loom width 织机幅宽	Tape length 剑带长度	WJT Code WJT编号
210	1900	104 1900
330	2450	104 2450
380	2700	104 2700
420	3100	104 3100
460	3400	104 3400

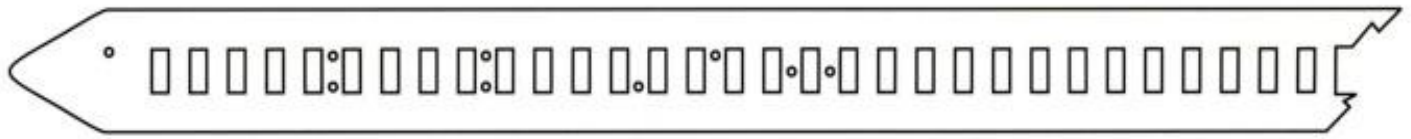

UV770

RIGHT-LEFT / 右-左 THICKNE / 厚度 2.5		
Loom width 织机幅宽	Tape length 剑带长度	WJT Code WJT编号
190	1920	105 1920
210	2020	105 2020
230	2120	105 2120
260	2360	105 2360
300	2560	105 2560
340	2760	105 2760
360	2880	105 2880

RIGHT-LEFT / 右-左 THICKNE / 厚度 3		
Loom width 织机幅宽	Tape length 剑带长度	WJT Code WJT编号
190	1690	106 1690
210	1790	106 1790
230	1890	106 1890
260	2130	106 2130
300	2330	106 2330
340	2530	106 2530
360	2650	106 2650



ST880

RIGHT-LEFT / 右-左		
Loom width 织机幅宽	Tape length 剑带长度	WJT Code WJT编号
190	1956	107 1956
220	2044	107 2044
230	2154	107 2154
260	2395	107 2395
310	2593	107 2593
340	2790	107 2790
360	2900	107 2900

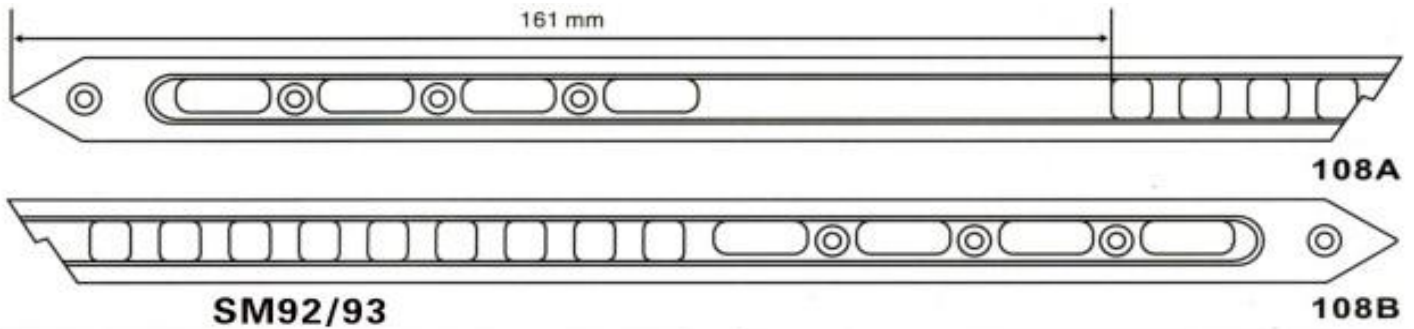

RIGHT-LEFT / 右-左		
Loom width 织机幅宽	Tape length 剑带长度	WJT Code WJT编号
165	1891	108A 1891
190	2001	108A 2001
210-220	2155	108A 2155
230	2199	108A 2199
260	2418	108A 2418
280	2528	108A 2528
320	2725	108A 2725
340	2813	108A 2813
360	2923	108A 2923
380	3021	108A 3021
420	3218	108A 3218
460	3406	108A 3406

RIGHT-LEFT / 右-左		
Loom width 织机幅宽	Tape length 剑带长度	WJT Code WJT编号
165	1891	108B 1891
190	2001	108B 2001
210-220	2155	108B 2155
230	2199	108B 2199
260	2418	108B 2418
280	2528	108B 2528
320	2725	108B 2725
340	2813	108B 2813
360	2923	108B 2923
380	3021	108B 3021
420	3218	108B 3218
460	3406	108B 3406

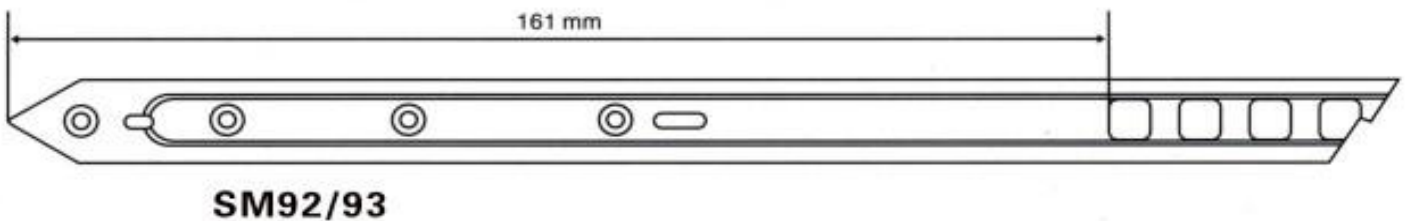

(FOR THEMA GRIPPER) (适用THEMA 剑头)

RIGHT-LEFT / 右-左		
Loom width 织机幅宽	Tape length 剑带长度	WJT Code WJT编号
165	1892	109 1892
190	2000	109 2000
210	2154	109 2154
230	2198	109 2198
260	2417	109 2417
280	2527	109 2527
320	2724	109 2724
340	2812	109 2812
360	2922	109 2922
380	3020	109 3020
420	3219	109 3219
460	3405	109 3405

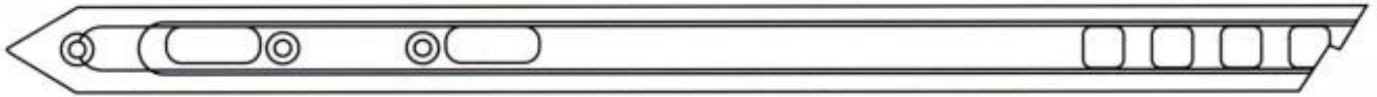

THEMA

RIGHT-LEFT / 右-左		
Loom width 织机幅宽	Tape length 剑带长度	WJT Code WJT编号
165	2099	110 2099
190	2209	110 2209
210-220	2362	110 2362
230	2418	110 2418
260	2626	110 2626
280	2725	110 2725
300-320	2923	110 2923
340	3021	110 3021
360	3130	110 3130
380	3218	110 3218
400	3406	110 3406
420	3525	110 3525
460	3745	110 3745

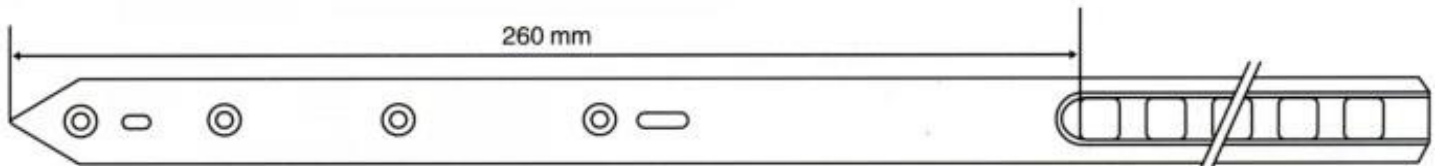

THEMA 11 E

RIGHT-LEFT / 右-左		
Loom width 织机幅宽	Tape length 剑带长度	WJT Code WJT编号
165	2056	111 2056
190	2187	111 2187
210	2287	111 2287
220	2330	111 2330
230	2385	111 2385
260	2593	111 2593
280	2692	111 2692
300	2791	111 2791
320	2890	111 2890
340	2988	111 2988
360	3098	111 3098
380	3197	111 3197
400	3295	111 3295

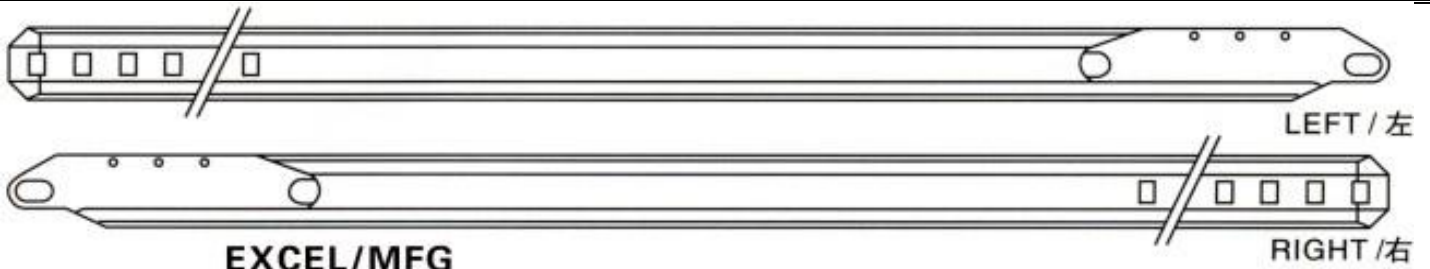

EXCEL/MFG

RIGHT / 右		
Loom width 织机幅宽	Tape length 剑带长度	WJT Code WJT编号
165	1980	112 1980
190	2104	112 2104
210	2203	112 2203
220	2253	112 2253
230	2303	112 2303
260	2517	112 2517
280	2616	112 2616
300	2715	112 2715
320	2814	112 2814
340	2913	112 2913
360	3012	112 3012
380	3119	112 3119
400	3218	112 3218

LEFT / 左		
Loom width 织机幅宽	Tape length 剑带长度	WJT Code WJT编号
165	1980	113 1980
190	2104	113 2104
210	2203	113 2203
220	2253	113 2253
230	2303	113 2303
260	2517	113 2517
280	2616	113 2616
300	2715	113 2715
320	2814	113 2814
340	2913	113 2913
360	3012	113 3012
380	3119	113 3119
400	3218	113 3218

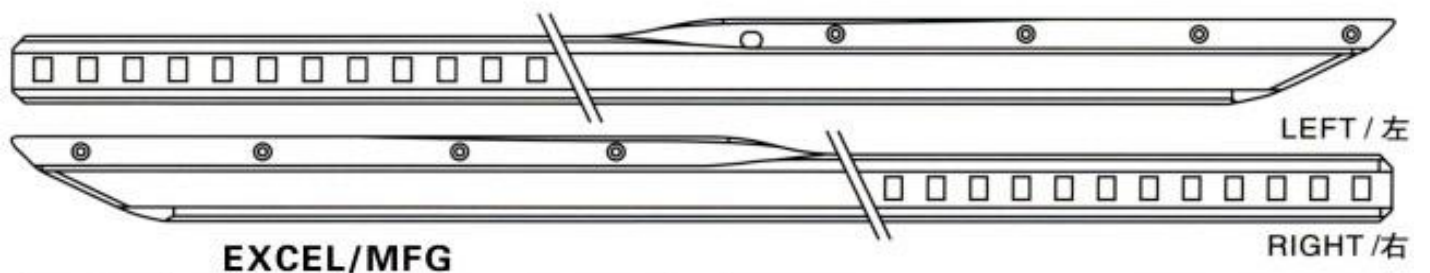

EXCEL/MFG

LEFT / 左		
Loom width 织机幅宽	Tape length 剑带长度	WJT Code WJT编号
132	1964	114 1964
165	2128	114 2128
190	2252	114 2252
210	2351	114 2351
220	2400	114 2400
230	2450	114 2450
260	2664	114 2664
280	2763	114 2763
300	2862	114 2862
320	2961	114 2961
340	3060	114 3060
360	3159	114 3159
380	3267	114 3267
400	3366	114 3366

RIGHT / 右		
Loom width 织机幅宽	Tape length 剑带长度	WJT Code WJT编号
132	1964	115 1964
165	2128	115 2128
190	2252	115 2252
210	2351	115 2351
220	2400	115 2400
230	2450	115 2450
260	2664	115 2664
280	2763	115 2763
300	2862	115 2862
320	2961	115 2961
340	3060	115 3060
360	3159	115 3159
380	3267	115 3267
400	3366	115 3366



ALPHA GFG

RIGHT-LEFT / 右-左		
Loom width 织机幅宽	Tape length 剑带长度	WJT Code WJT编号
170	2175	116 2175
190	2258	116 2258
210	2357	116 2357
220	2398	116 2398
230	2456	116 2456
260	2663	116 2663
280	2763	116 2763
300	2862	116 2862
320	2961	116 2961
340	3060	116 3060
360	3168	116 3168
380	3267	116 3267
400	3367	116 3367
420	3466	116 3466
460	3665	116 3665

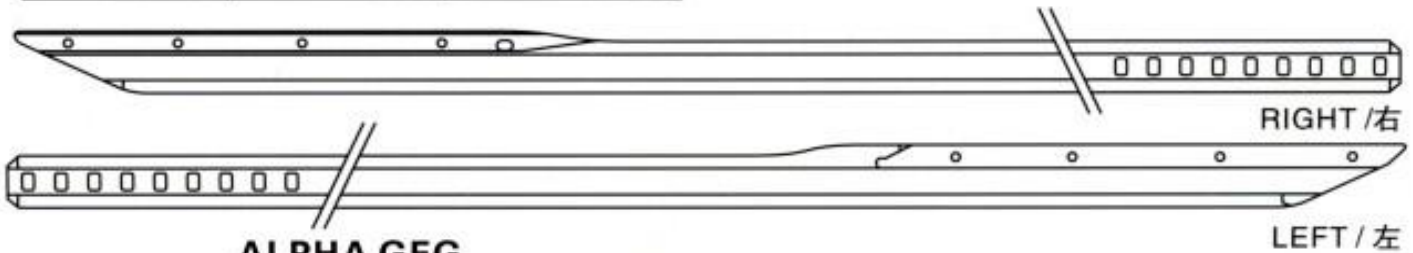

ALPHA GFG

RIGHT / 右		
Loom width 织机幅宽	Tape length 剑带长度	WJT Code WJT编号
170	2285	117 2285
190	2360	117 2360
210	2459	117 2459
220	2508	117 2508
230	2558	117 2558
260	2772	117 2772
280	2871	117 2871
300	2970	117 2970
320	3069	117 3069
340	3168	117 3168
360	3267	117 3267
380	3374	117 3374
400	3473	117 3473
420	3671	117 3671
460	4076	117 4076

LEFT / 左		
Loom width 织机幅宽	Tape length 剑带长度	WJT Code WJT编号
170	2285	118 2285
190	2360	118 2360
210	2459	118 2459
220	2508	118 2508
230	2558	118 2558
260	2772	118 2772
280	2871	118 2871
300	2970	118 2970
320	3069	118 3069
340	3168	118 3168
360	3267	118 3267
380	3374	118 3374
400	3473	118 3473
420	3671	118 3671
460	4076	118 4076

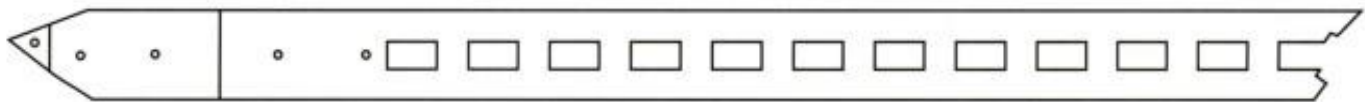

C301/401

RIGHT-LEFT / 右-左		
Loom width 织机幅宽	Tape length 剑带长度	WJT Code WJT编号
160	1780	201 1780
190	1920	201 1920
210	2015	201 2015
230	2110	201 2110
260	2275	201 2275
300	2515	201 2515
320	2610	201 2610
340	2705	201 2705
360	2800	201 2800
380	2895	201 2895



C201/401

织布机门幅 Loom Space	剑杆带长度 Tape Length	备注 Remarks
H1900	L1800mm	左 / LEFT 右 / RIGHT
H2200	L1950mm	
H2300	L2000mm	
H2600	L2150mm	
H3000	L2350mm	
H3400	L2550mm	
H3600	L2630mm	

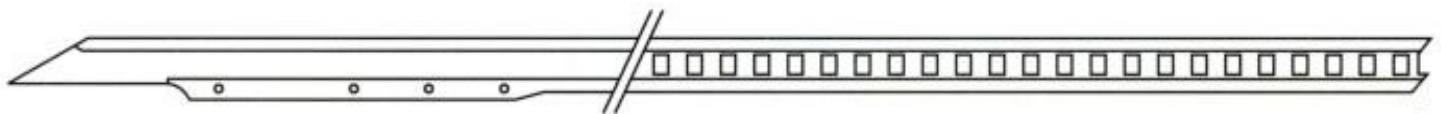

RIGHT / 右

RIGHT

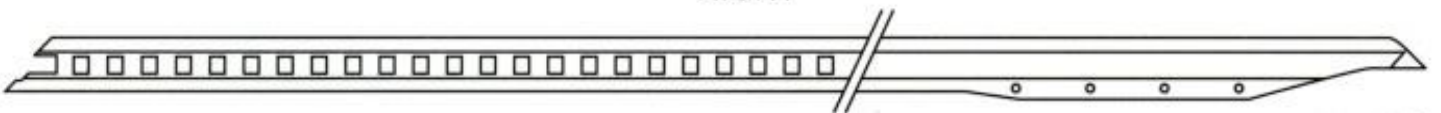

LEFT / 左

LEFT

P1001

RIGHT / 右		
Loom width 织机幅宽	Tape length 剑带长度	WJT Code WJT编号
1600	2030	202 2030
1900	2180	202 2180
2100	2280	202 2280
2300	2380	202 2380
2600	2530	202 2530
3000	2760	202 2760
3200	2860	202 2860
3400	2960	202 2960
3600	3060	202 3060
3800	3160	202 3160

LEFT / 左		
Loom width 织机幅宽	Tape length 剑带长度	WJT Code WJT编号
1600	2190	203 2190
1900	2340	203 2340
2100	2440	203 2440
2300	2540	203 2540
2600	2690	203 2690
3000	2920	203 2920
3200	3020	203 3020
3400	3120	203 3120
3600	3220	203 3220
3800	3320	203 3320

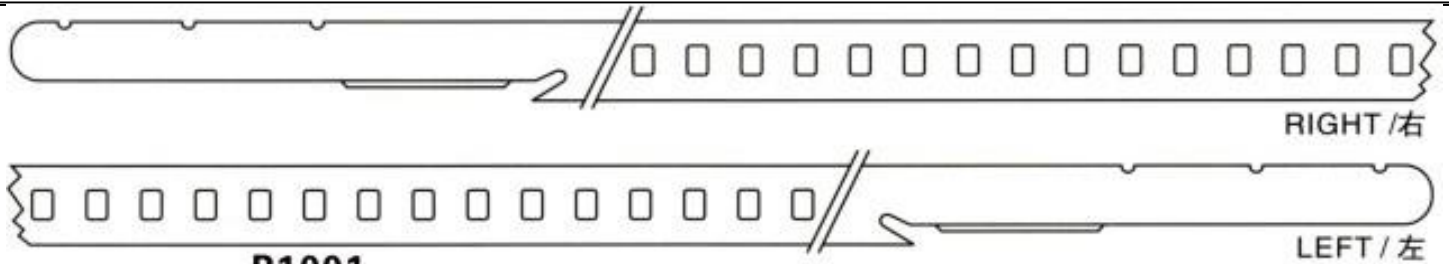

P1001
(CHANGEABLE CARBON POINT 可更换头部)

RIGHT / 右		
Loom width 织机幅宽	Tape length 剑带长度	WJT Code WJT编号
160	1945	204 1945
190	2095	204 2095
210	2195	204 2195
230	2295	204 2295
260	2445	204 2445
280	2545	204 2545
300	2675	204 2675
320	2775	204 2775
340	2875	204 2875
360	2975	204 2975
380	3075	204 3075

LEFT / 左		
Loom width 织机幅宽	Tape length 剑带长度	WJT Code WJT编号
160	2130	205 2130
190	2280	205 2280
210	2380	205 2380
230	2480	205 2480
260	2630	205 2630
280	2730	205 2730
300	2860	205 2860
320	2960	205 2960
340	3060	205 3060
360	3160	205 3160
380	3260	205 3260

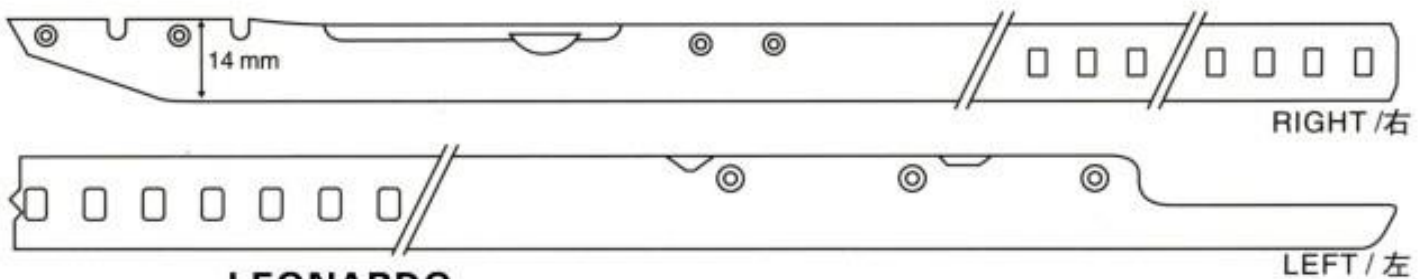

LEONARDO

RIGHT / 右		
Loom width 织机幅宽	Tape length 剑带长度	WJT Code WJT编号
170	2122	206 2122
190	2222	206 2222
210	2322	206 2322
220	2372	206 2372
230	2422	206 2422
260	2572	206 2572
280	2672	206 2672
300	2802	206 2802
320	2902	206 2902
340	3002	206 3002
360	3102	206 3102
380	3202	206 3202

LEFT / 左		
Loom width 织机幅宽	Tape length 剑带长度	WJT Code WJT编号
170	2230	207 2230
190	2330	207 2330
210	2430	207 2430
220	2480	207 2480
230	2530	207 2530
260	2680	207 2680
280	2780	207 2780
300	2910	207 2910
320	3010	207 3010
340	3110	207 3110
360	3210	207 3210
380	3310	207 3310

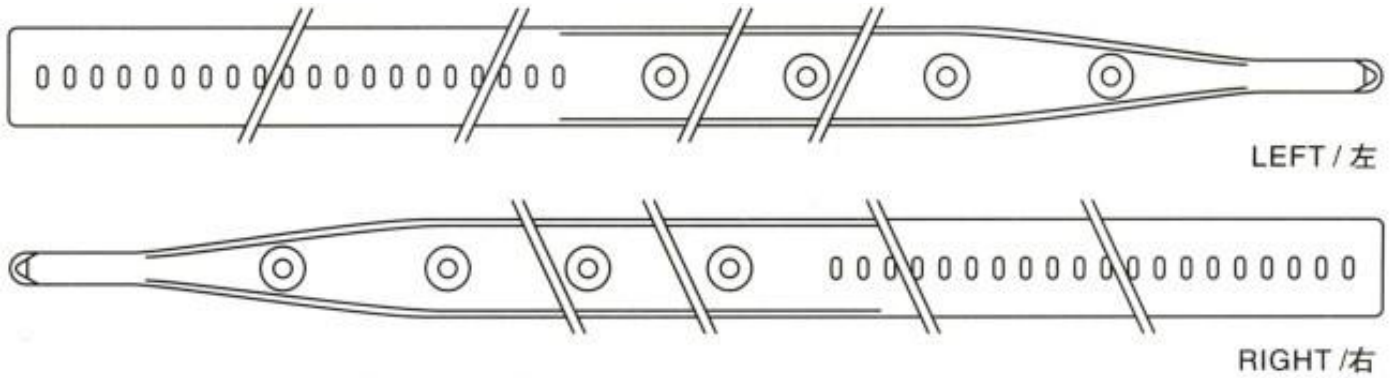

LEONARDO FTS

LEFT / 左		
Loom width 织机幅宽	Tape length 剑带长度	WJT Code WJT编号
170	2275	208 2275
190	2375	208 2375
210	2475	208 2475
220	2525	208 2525
230	2575	208 2575
260	2725	208 2725
280	2825	208 2825
300	2955	208 2955
320	3055	208 3055
340	3155	208 3155
360	3255	208 3255
380	3355	208 3355

RIGHT / 右		
Loom width 织机幅宽	Tape length 剑带长度	WJT Code WJT编号
170	2065	209 2065
190	2165	209 2165
210	2265	209 2265
220	2315	209 2315
230	2365	209 2365
260	2515	209 2515
280	2615	209 2615
300	2745	209 2745
320	2845	209 2845
340	2945	209 2945
360	3045	209 3045
380	3145	209 3145

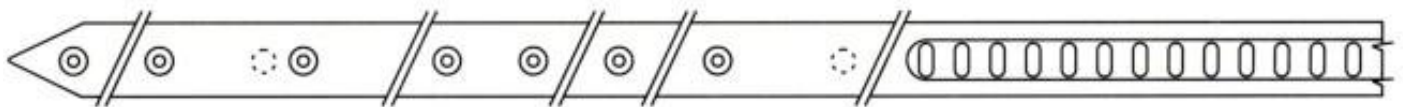

9000 PLUS
(THICKNESS/厚度3)

RIGHT-LEFT / 右-左		
Loom width 织机幅宽	Tape length 剑带长度	WJT Code WJT编号
190	2450	210 2450
210	2550	210 2550
230	2650	210 2650
260	2800	210 2800
280	2900	210 2900
300	3030	210 3030
320	3130	210 3130
340	3230	210 3230
360	3330	210 3330
380	3430	210 3430

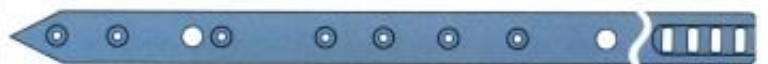

左、右/LEFT-RIGHT
厚度THICKNESS: 3mm

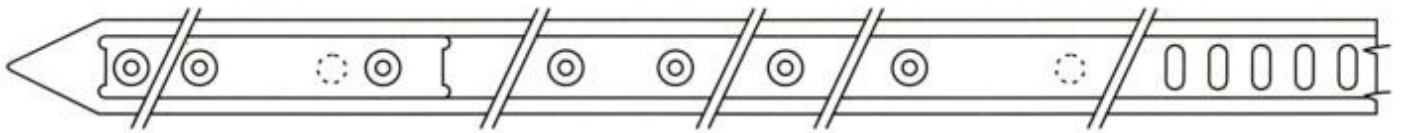

9000 PLUS
(THICKNESS/厚度4)

RIGHT-LEFT / 右-左		
Loom width 织机幅宽	Tape length 剑带长度	WJT Code WJT编号
190	2450	211 2450
210	2550	211 2550
230	2650	211 2650
260	2800	211 2800
280	2900	211 2900
300	3030	211 3030
320	3130	211 3130
340	3230	211 3230
360	3330	211 3330
380	3430	211 3430

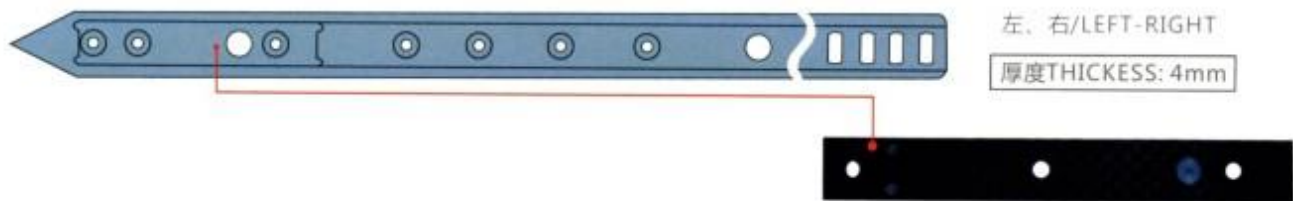

左、右/LEFT-RIGHT
厚度THICKNESS: 4mm

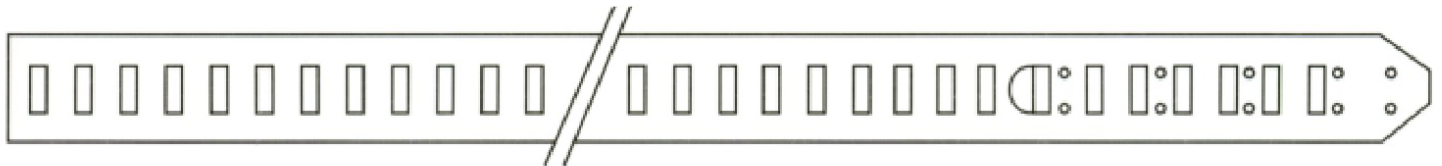

PGW

RIGHT-LEFT / 右-左		
Loom width 织机幅宽	Tape length 剑带长度	WJT Code WJT编号
200	1478.4	301 1478
245	1707.0	301 1707
282	1897.5	301 1897
300	1986.5	301 1986



PGW

12 holes / 孔

RIGHT-LEFT / 右-左		
Loom width 织机幅宽	Tape length 剑带长度	WJT Code WJT编号
190	1519.4	302 1519
245	1748.0	302 1748
282	1938.5	302 1938
300	2021.4	302 2021
350	2281.9	302 2281



PGW

18 holes / 孔

RIGHT-LEFT / 右-左		
Loom width 织机幅宽	Tape length 剑带长度	WJT Code WJT编号
190-200	1519.4	303 1519
245	1748.0	303 1748
282	1938.5	303 1938
300	2027.4	303 2027
350	2281.4	303 2281



PGW 200T

RIGHT-LEFT / 右-左		
Loom width 织机幅宽	Tape length 剑带长度	WJT Code WJT编号
200	1519.4	304 1519
245	1748.8	304 1748
282	1938.5	304 1938
300	2027.4	304 2027
350	2281.4	304 2281

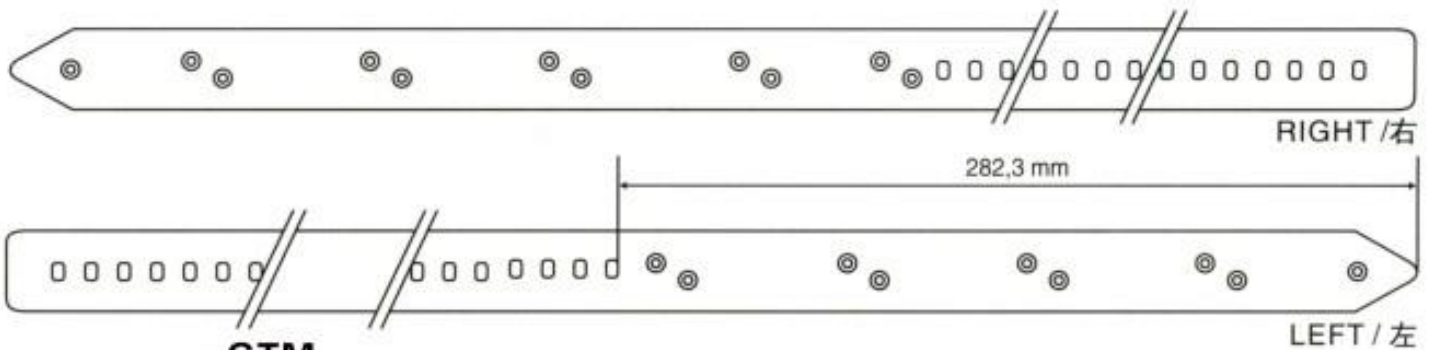

GTM

RIGHT / 右		
Loom width 织机幅宽	Tape length 剑带长度	WJT Code WJT编号
190	2161	305 2161
220-240	2631	305 2631
280	2948	305 2948

LEFT / 左		
Loom width 织机幅宽	Tape length 剑带长度	WJT Code WJT编号
190	2174	306 2174
220-240	2631	306 2631
280	2961	306 2961

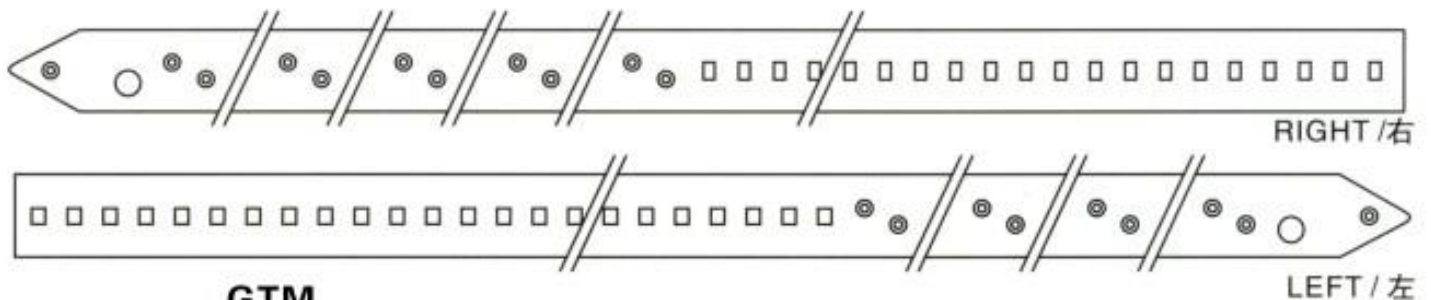

GTM

RIGHT / 右		
Loom width 织机幅宽	Tape length 剑带长度	WJT Code WJT编号
190	2161	307 2161
220-240	2631	307 2631
280	2948	307 2948

LEFT / 左		
Loom width 织机幅宽	Tape length 剑带长度	WJT Code WJT编号
190	2174	308 2174
220-240	2631	308 2631
280	2961	308 2961

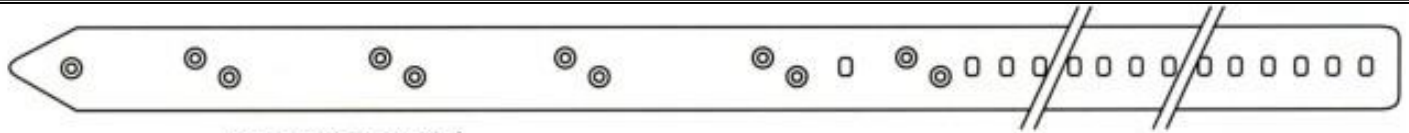

GTM(通用型)

RIGHT-LEFT / 右-左		
Loom width 织机幅宽	Tape length 剑带长度	WJT Code WJT编号
190	2173	309 2173
220-240	2631	309 2631
280	2961	309 2961

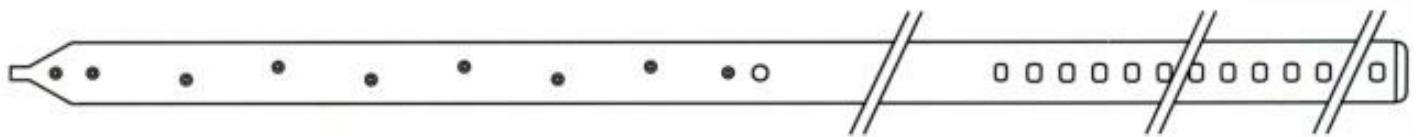

RIGHT / 右

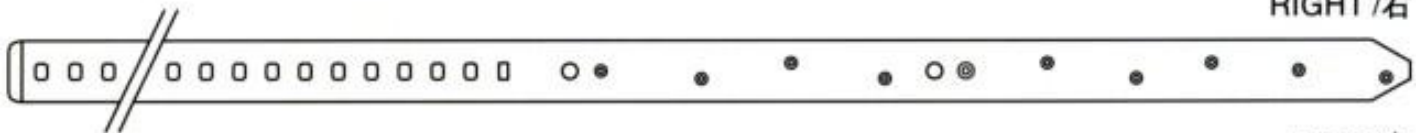

LEFT / 左

GTX

RIGHT / 右		
Loom width 织机幅宽	Tape length 剑带长度	WJT Code WJT编号
190	2193	310 2193
220-240	2612	310 2612
280	2943	310 2943

LEFT / 左		
Loom width 织机幅宽	Tape length 剑带长度	WJT Code WJT编号
190	2218	311 2218
220-240	2574	311 2574
280	2904	311 2904

LEFT / 左		
Loom width 织机幅宽	Tape length 剑带长度	WJT Code WJT编号
190	2155	312 2155

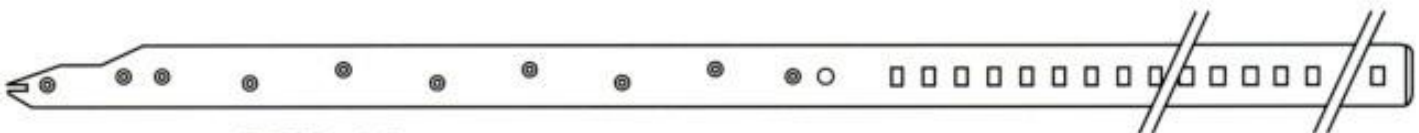

GTM-AS

RIGHT / 右 (16.5MM)		
Loom width 织机幅宽	Tape length 剑带长度	WJT Code WJT编号
190	2269	313 2269
220-240	2637	313 2637
280	2967	313 2967

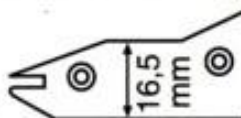

RIGHT / 右 (14.5MM)		
Loom width 织机幅宽	Tape length 剑带长度	WJT Code WJT编号
190	2218	314 2218
220-240	2637	314 2637
280	2967	314 2967

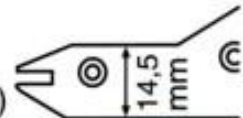

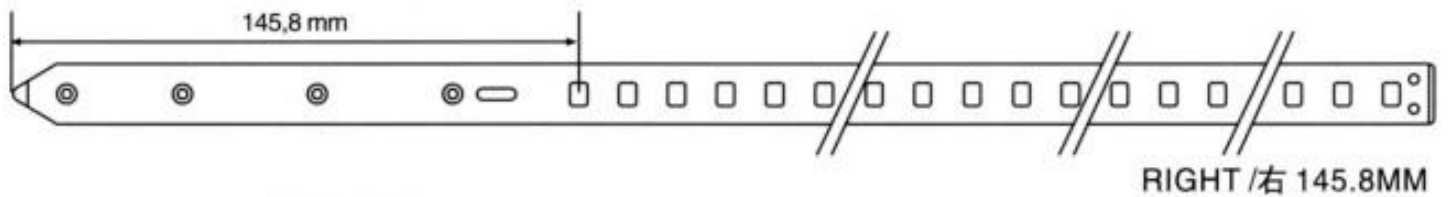
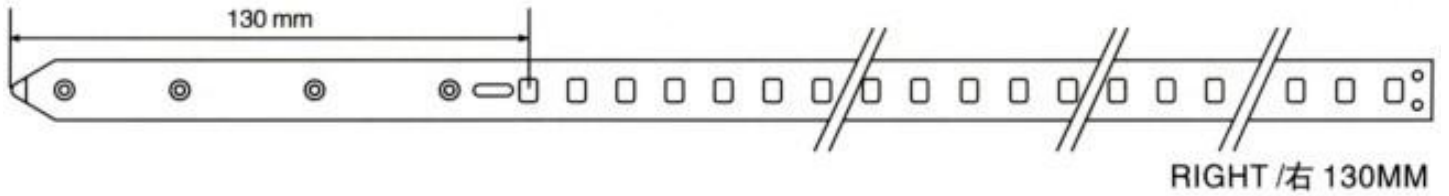
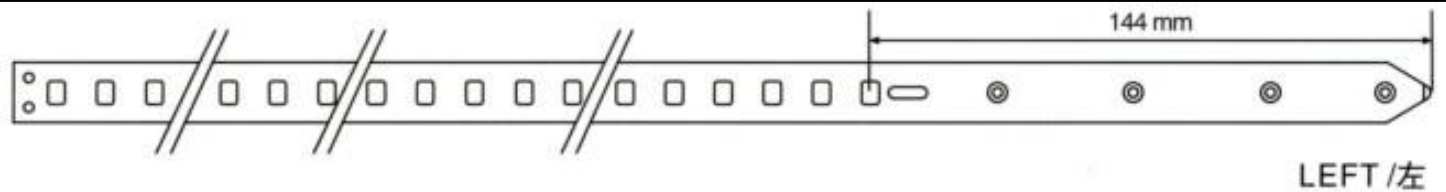

GAMMA190

LEFT / 左		
Loom width 织机幅宽	Tape length 剑带长度	WJT Code WJT编号
190	1704	315 1704

RIGHT / 右 130MM		
Loom width 织机幅宽	Tape length 剑带长度	WJT Code WJT编号
190	1728	316 1728

RIGHT / 右 145.8MM		
Loom width 织机幅宽	Tape length 剑带长度	WJT Code WJT编号
190	1743	317 1743

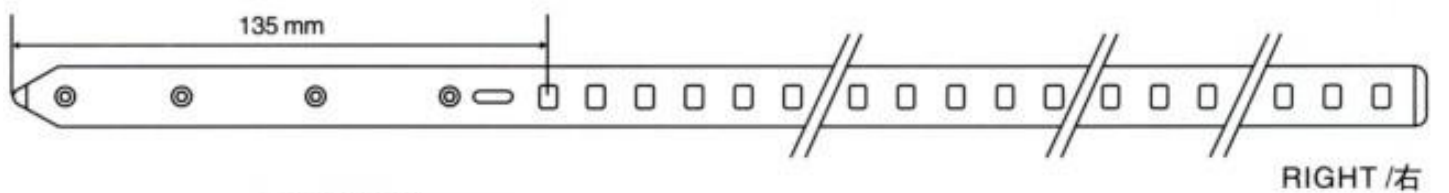
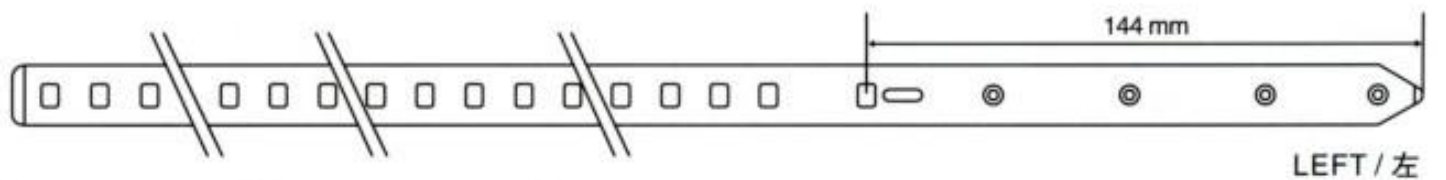

GAMMA

LEFT / 左		
Loom width 织机幅宽	Tape length 剑带长度	WJT Code WJT编号
220	2580	318 2580
250	2735	318 2735
300	2974	318 2974
340	3177	318 3177

RIGHT / 右		
Loom width 织机幅宽	Tape length 剑带长度	WJT Code WJT编号
220	2608	319 2608
250	2764	319 2764
300	3003	319 3003
340	3219	319 3219

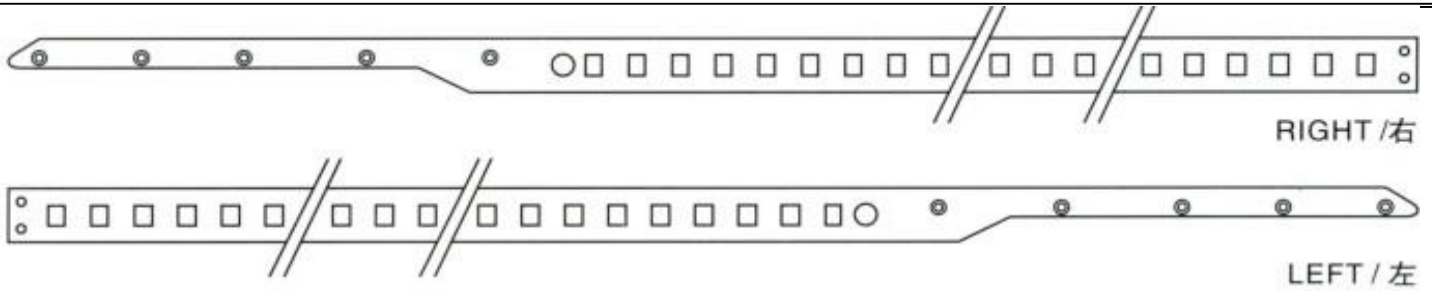

GAMMA98 190

RIGHT / 右		
Loom width 织机幅宽	Tape length 剑带长度	WJT Code WJT编号
190	1769	320 1769

LEFT / 左		
Loom width 织机幅宽	Tape length 剑带长度	WJT Code WJT编号
190	1732	321 1732

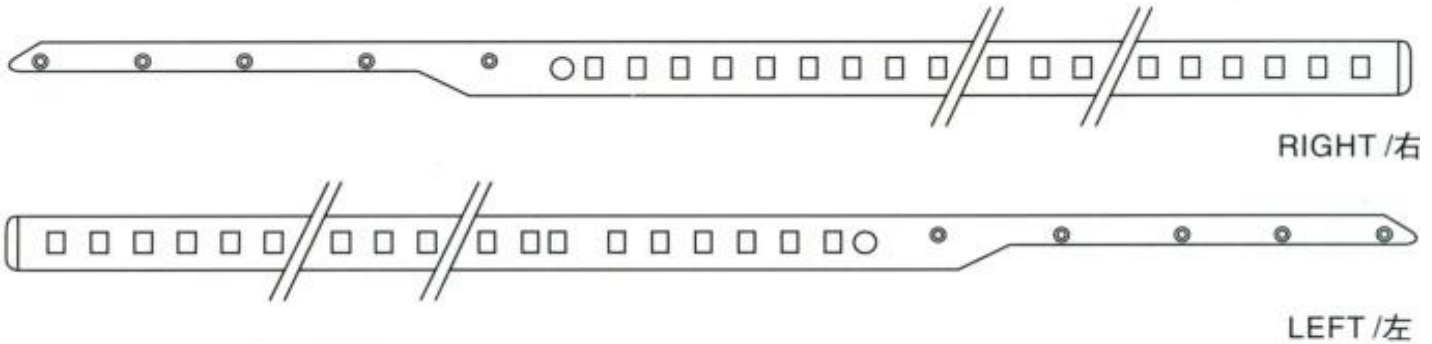

GAMMA98

RIGHT / 右		
Loom width 织机幅宽	Tape length 剑带长度	WJT Code WJT编号
220	2649	322 2649
250	2802	322 2802
300	3043	322 3043
340	3259	322 3259
380	3437	322 3437

LEFT / 左		
Loom width 织机幅宽	Tape length 剑带长度	WJT Code WJT编号
220	2612	323 2612
250	2764	323 2764
300	3006	323 3006
340	3209	323 3209
380	3412	323 3412



PICANOL GAMMA Tape(Carbon)

GAMMA TAPE(carbon) GRIPPER(abon) LINK BLOCK



GAMMA TAPE(carbon) GRIPPER(abon) LINK BLOCK

PICANOL GAMMA Tape(Carbon)

PICANOL GAMMA Tape(Carbon)

织布机门幅 Loom Space	剑杆带长度 Tape Length	备注 Remarks
	L2687mm	
	L2711mm	
	L2740mm	

织布机门幅 Loom Space	剑杆带长度 Tape Length	备注 Remarks

GAMMAX

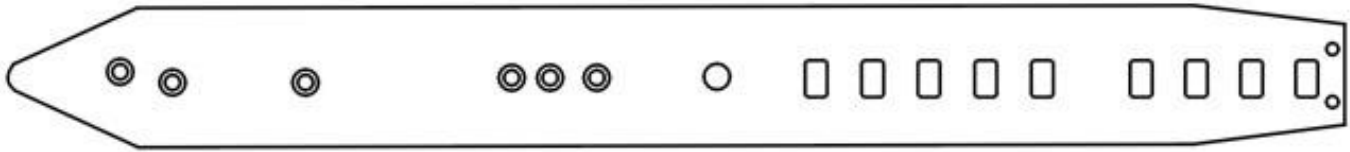

织布机门幅 Loom Space	剑杆带长度 Tape Length	备注 Remarks
H1900	L1808mm	左 / LEFT
H2100	L2668mm	
H2200	L2711mm	
H2300	L2767mm	
H2500	L2864mm	
H3000	L3113mm	
H3200	L3214mm	
H3400	L3322mm	

GAMMAX

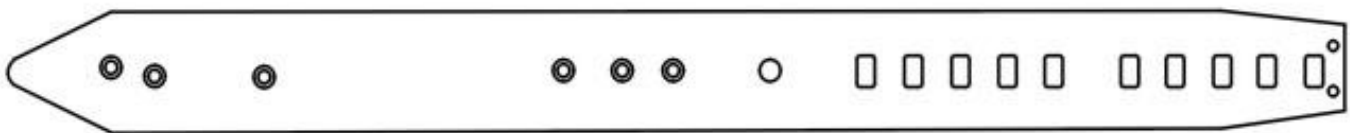

织布机门幅 Loom Space	剑杆带长度 Tape Length	备注 Remarks
H1900	L1846mm	右 / RIGHT
H2200	L2737mm	
H2500	L2890mm	
H3000	L3138mm	
H3400	L3348mm	

GAMMAX

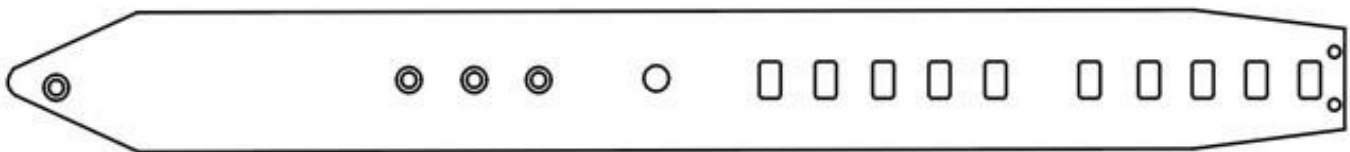

织布机门幅 Loom Space	剑杆带长度 Tape Length	备注 Remarks
H1900	L1796mm	右 / RIGHT
H2100	L2643mm	
H2200	L2687mm	
H2300	L2742mm	
H2500	L2840mm	
H3000	L3088mm	
H3200	L3189mm	
H3400	L3298mm	

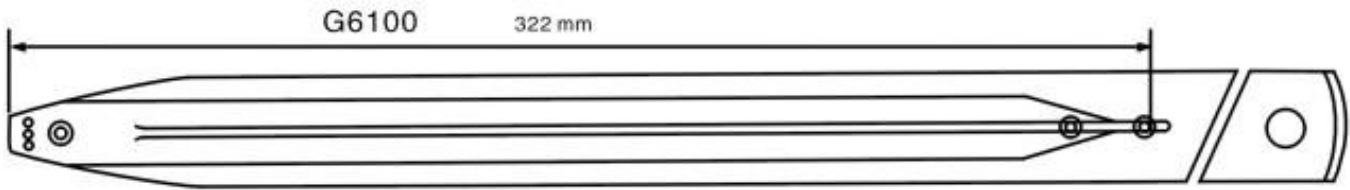

织布机门幅 Loom Space	剑杆带长度 Tape Length	备注 Remarks
H1400-1600	L1638mm	左 / LEFT 右 / RIGHT
H1700-1900	L1756mm	
H2000-2200	L1906mm	
H2300-2500	L2071mm	
H2600-2800	L2228mm	

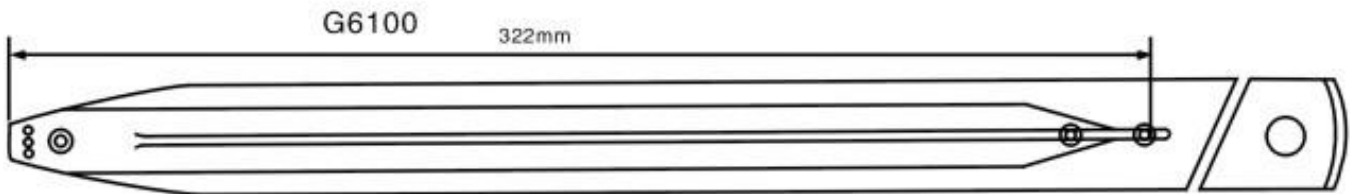

织布机门幅 Loom Space	剑杆带长度 Tape Length	备注 Remarks
H1400-1600	L1638mm	左 / LEFT
H1700-1900	L1756mm	
H2000-2200	L1906mm	
H2300-2500	L2071mm	
H2600-2800	L2228mm	

厚度 1.6mm

织布机门幅 Loom Space	剑杆带长度 Tape Length	备注 Remarks
H1400-1600	L1573mm	右 / RIGHT
H1700-1900	L1691mm	
H2000-2200	L1841mm	
H2300-2500	L2006mm	
H2600-2800	L2163mm	

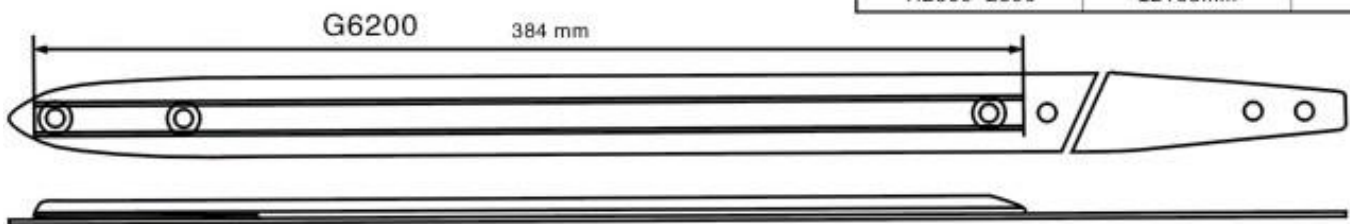

厚度 1.1mm
厚度 1.2mm

织布机门幅 Loom Space	剑杆带长度 Tape Length	备注 Remarks
	L1884mm	左 / LEFT 右 / RIGHT
	L2134mm	
	L2434mm	
	L2684mm	

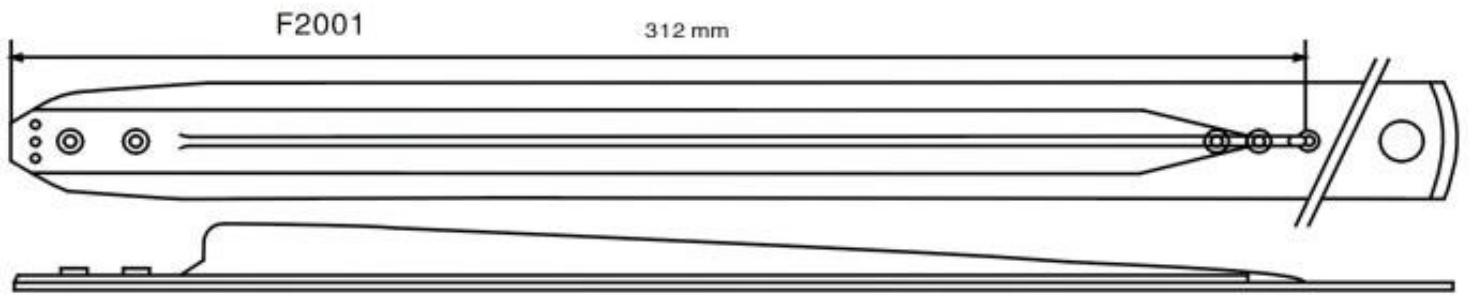

厚度 1.3mm
厚度 1.6mm

织布机门幅 Loom Space	剑杆带长度 Tape Length	备注 Remarks
H1400-1600	L1592mm	右 / RIGHT
H1700-1900	L1710mm	
H1700-1900	L1675mm	
H2000-2200	L1860mm	
H2300-2500	L2025mm	
H2600-2800	L2182mm	

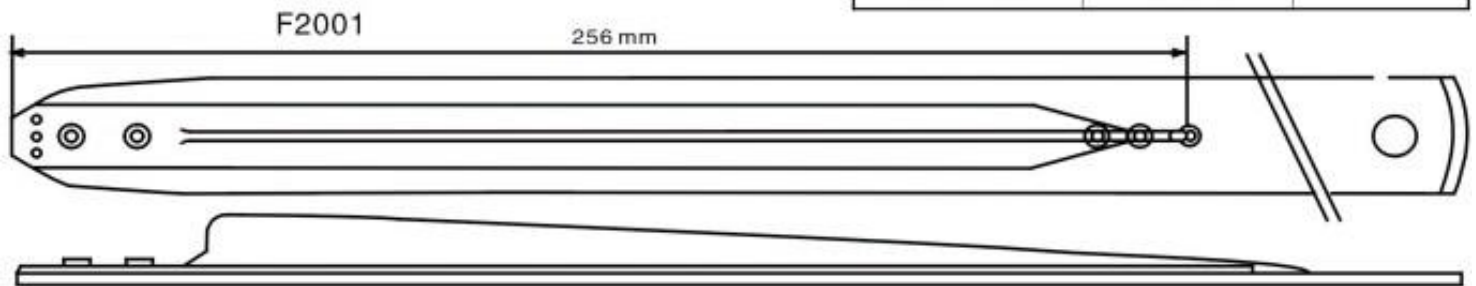

厚度 1.3mm
厚度 1.6mm

织布机门幅 Loom Space	剑杆带长度 Tape Length	备注 Remarks
H1400-1600	L1542mm	左 / LEFT
H1700-1900	L1660mm	
H2000-2200	L1810mm	
H2300-2500	L1975mm	
H2600-2800	L2132mm	
H2900	L2179mm	

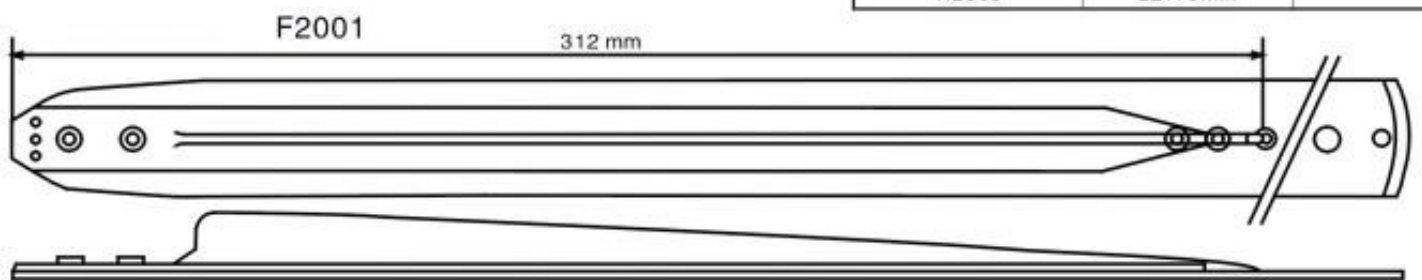

厚度 1.3mm
厚度 1.6mm

织布机门幅 Loom Space	剑杆带长度 Tape Length	备注 Remarks
H1400-1600	L1619mm	右 / RIGHT
H1700-1900	L1769mm	
H2000-2200	L1919mm	
H2300-2500	L2069mm	
H2600-2800	L2219mm	
H2900	L2269mm	

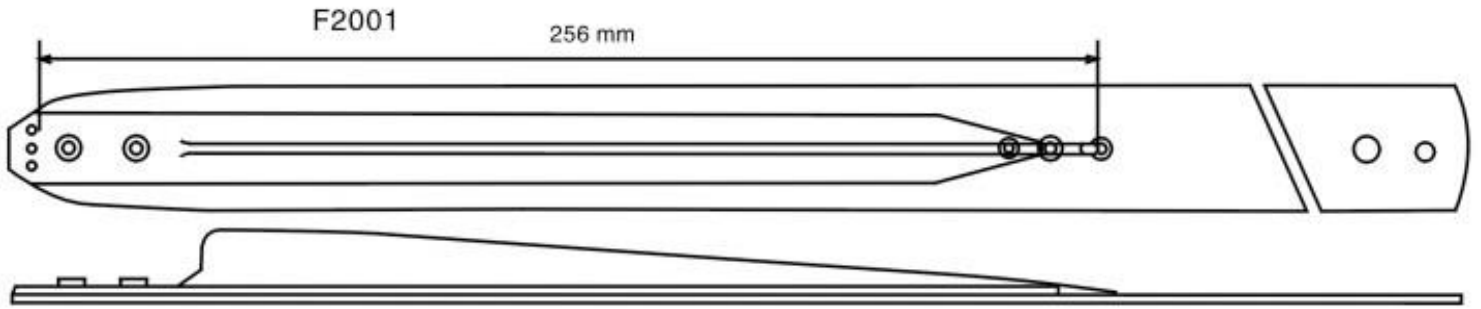

厚度 1.3mm
厚度 1.6mm

织布机门幅 Loom Space	剑杆带长度 Tape Length	备注 Remarks
H1400-1600	L1632mm	左 / LEFT
H1700-1900	L1782mm	
H2000-2200	L1932mm	
H2300-2500	L2082mm	
H2600-2800	L2232mm	
H2900	L2282mm	

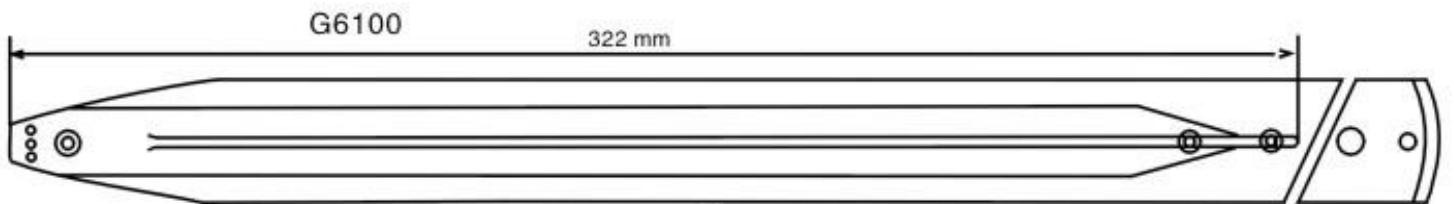

厚度 1.3mm
厚度 1.6mm

织布机门幅 Loom Space	剑杆带长度 Tape Length	备注 Remarks
H1400-1600	L1632mm	左 / LEFT 右 / RIGHT
H1700-1900	L1813mm	
H2000-2200	L1963mm	
H2300-2500	L2113mm	
H2600-2800	L2263mm	
H2900	L2363mm	

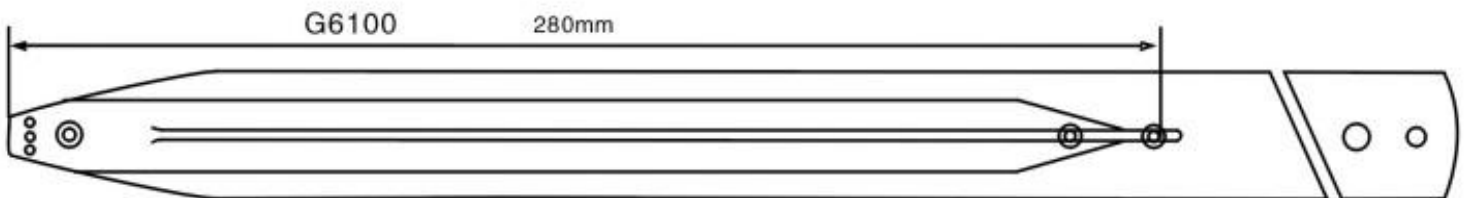

厚度 1.3mm

织布机门幅 Loom Space	剑杆带长度 Tape Length	备注 Remarks
H1400-1800	L1692mm	左 / LEFT
H1900-2100	L1842mm	
H2200-2500	L2042mm	
H2600-2900	L2242mm	

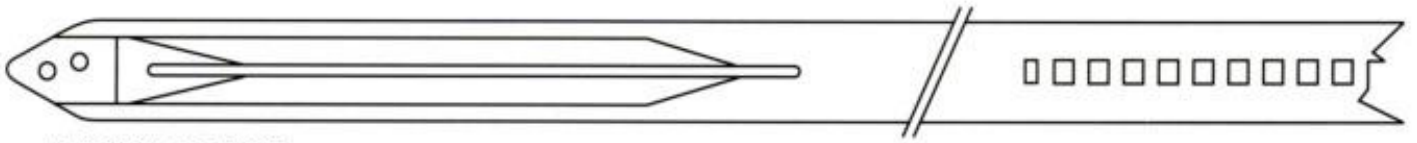

FAST/G6300

RIGHT-LEFT / 右-左		
Loom width 织机幅宽	Tape length 剑带长度	WJT Code WJT编号
170	2510	407 2510
190	2608	407 2608
200	2650	407 2650
220	2748	407 2748
240	2846	407 2846
260	2944	407 2944
290	3150	407 3150
320	3355	407 3355
340	3450	407 3450
360	3550	407 3550

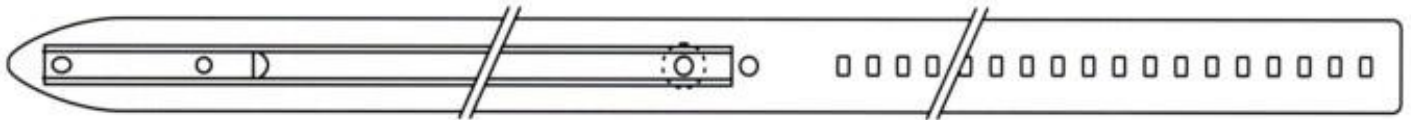

G6200

RIGHT-LEFT / 右-左		
Loom width 织机幅宽	Tape length 剑带长度	WJT Code WJT编号
170	2532	408 2532
190	2630	408 2630
200	2672	408 2672
220	2770	408 2770
230	2822	408 2822
240	2868	408 2868
260	2966	408 2966
290	3172	408 3172
320	3377	408 3377
340	3472	408 3472
360	3572	408 3572



TP300

RIGHT-LEFT / 右-左		
Loom width 织机幅宽	Tape length 剑带长度	WJT Code WJT编号
210	2010	401 2010
250	2213	401 2213
330	2620	401 2620
360	2766	401 2766
410	3016	401 3016



TP400

RIGHT-LEFT / 右-左		
Loom width 织机幅宽	Tape length 剑带长度	WJT Code WJT编号
200	1655	402 1655
220	1752	402 1752
240	1850	402 1850
260	1948	402 1948
290	2154	402 2154
330	2348	402 2348
360	2500	402 2500
410	2748	402 2748

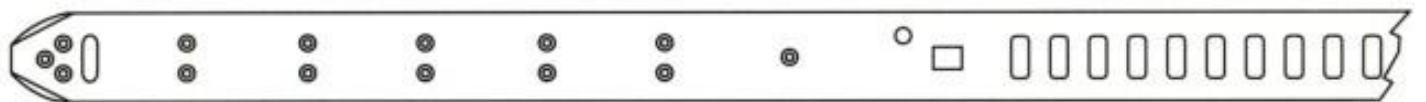

TP500

RIGHT-LEFT / 右-左		
Loom width 织机幅宽	Tape length 剑带长度	WJT Code WJT编号
200	2200	403 2200
220	2310	403 2310
240	2418	403 2418
260	2505	403 2505
290	2700	403 2700
330	2895	403 2895
360	3047	403 3047
380	3265	403 3265
440	3612	403 3612

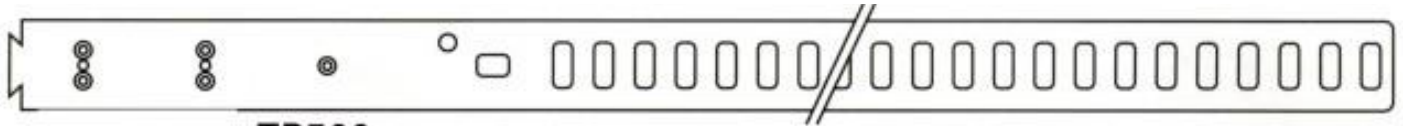

TP500

RIGHT-LEFT / 右-左		
Loom width 织机幅宽	Tape length 剑带长度	WJT Code WJT编号
200	2075	404 2075
220	2185	404 2185
240	2293	404 2293
260	2380	404 2380
290	2575	404 2575
330	2770	404 2770
360	2922	404 2922
380	3140	404 3140
440	3487	404 3487



TP600

RIGHT-LEFT / 右-左		
Loom width 织机幅宽	Tape length 剑带长度	WJT Code WJT编号
200	2200	405 2200
220	2310	405 2310
240	2418	405 2418
260	2505	405 2505
290	2700	405 2700
330	2895	405 2895
360	3047	405 3047
380	3265	405 3265
440	3612	405 3612



TP600

RIGHT-LEFT / 右-左		
Loom width 织机幅宽	Tape length 剑带长度	WJT Code WJT编号
200	2075	406 2075
220	2185	406 2185
240	2293	406 2293
260	2380	406 2380
290	2575	406 2575
330	2770	406 2770
360	2922	406 2922
380	3140	406 3140
440	3487	406 3487

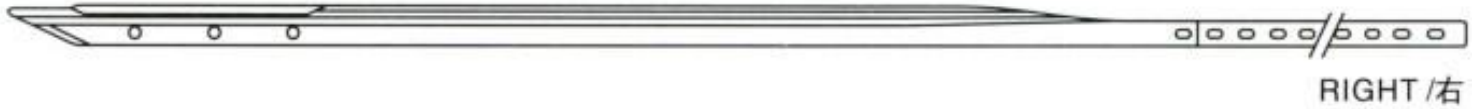

RIGHT / 右



LEFT / 左

PANTER E4X

RIGHT / 右		
Loom width 织机幅宽	Tape length 剑带长度	WJT Code WJT编号
190	2300 mm	601 2300
210	2405 mm	601 2405

LEFT / 左		
Loom width 织机幅宽	Tape length 剑带长度	WJT Code WJT编号
230	2470 mm	602 2470
360	3126 mm	602 3126

SAURER S350

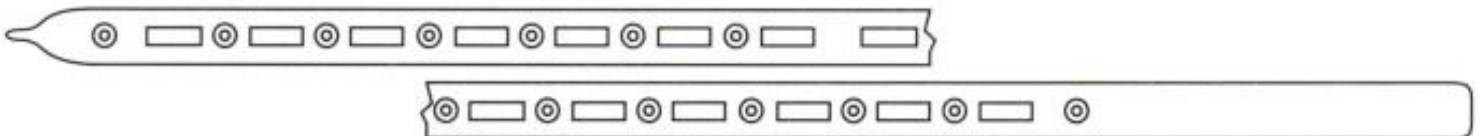

Loom width 织机幅宽	Tape length 剑带长度	WJT Code WJT编号
230	1780	701 1780
280	2083	701 2083
380	2792	701 2792

SAURER S500



Loom width 织机幅宽	Tape length 剑带长度	WJT Code WJT编号
	2824.72	702 1780



ISHIKAWA RAPIER TAPE 1001 FOR CARBON SUPPORT WIDTH 24 mm. LEFT



ISHIKAWA RAPIER TAPE 1001 FOR CARBON SUPPORT WIDTH 24 mm. RIGHT



ISHIKAWA RAPIER TAPE 1001 FOR CARBON SUPPORT WIDTH 30 mm. LEFT



ISHIKAWA RAPIER TAPE 1001 FOR CARBON SUPPORT WIDTH 30 mm. RIGHT

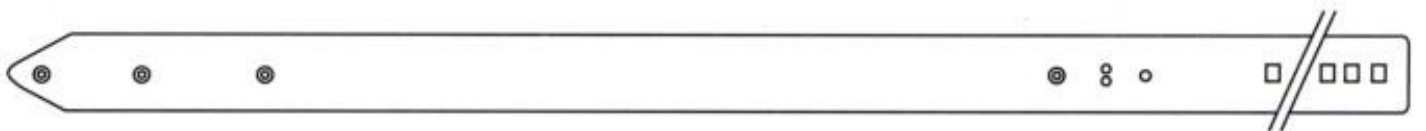

ISHIKAWA RAPIER TAPE 1001 WIDTH 30 mm. THICKNESS 2.5mm LEFT

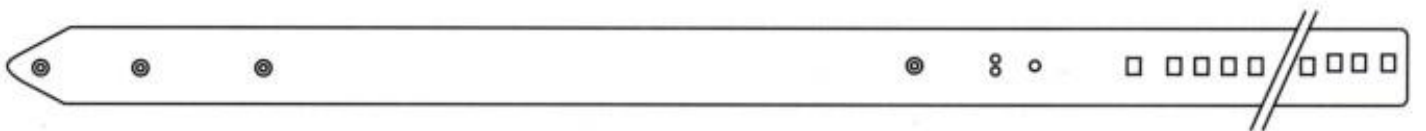

ISHIKAWA RAPIER TAPE 1001 WIDTH 30 mm. THICKNESS 2.5mm RIGHT

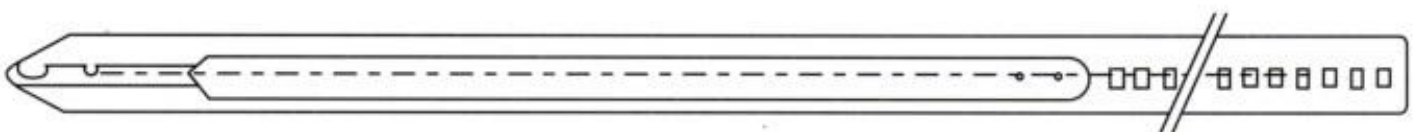

ISHIKAWA RAPIER TAPE 2001 IN CARBON

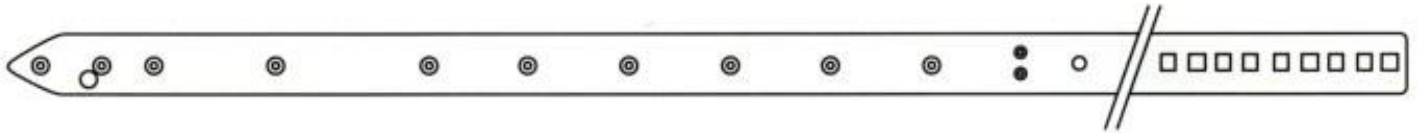

ISHIKAWA RAPIER TAPE 1001 FOR NYLON SUPPORT WIDTH 24 mm. LEFT

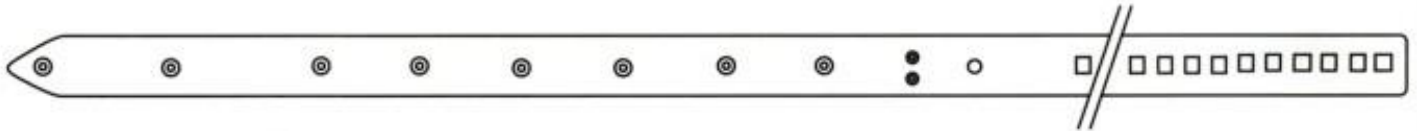

ISHIKAWA RAPIER TAPE 1001 FOR NYLON SUPPORT WIDTH 24 mm. RIGHT

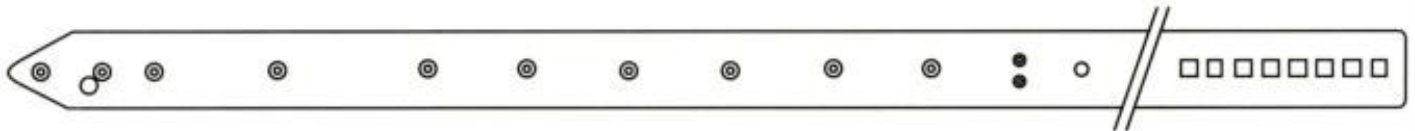

ISHIKAWA RAPIER TAPE 1001 FOR NYLON SUPPORT WIDTH 30 mm. LEFT

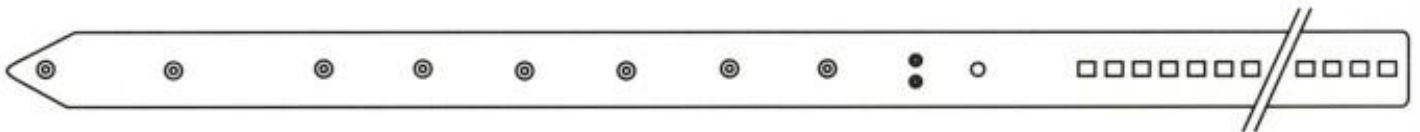

ISHIKAWA RAPIER TAPE 1001 FOR NYLON SUPPORT WIDTH 30 mm. RIGHT

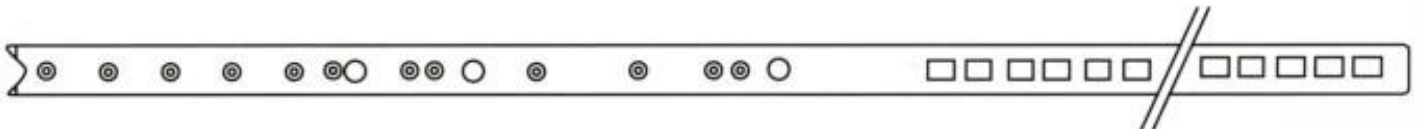

TSUDAKOMA RAPIER TAPE FR001

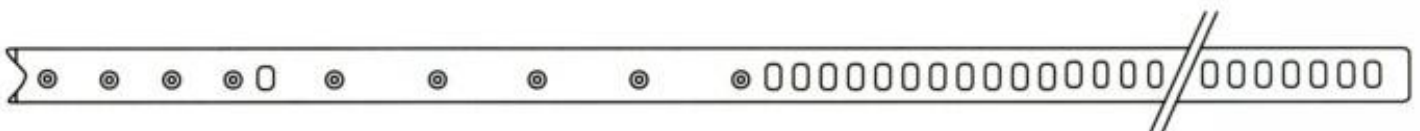

TSUDAKOMA RAPIER TAPE R550

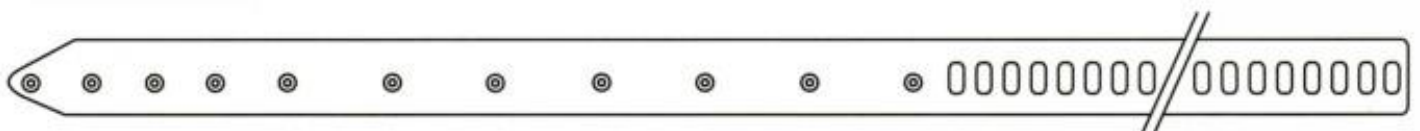

TSUDAKOMA RAPIER TAPE R300

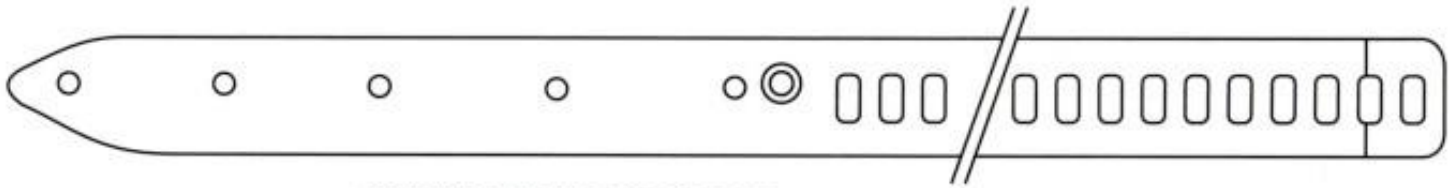

IMAMURA RAPIER TAPE TG107

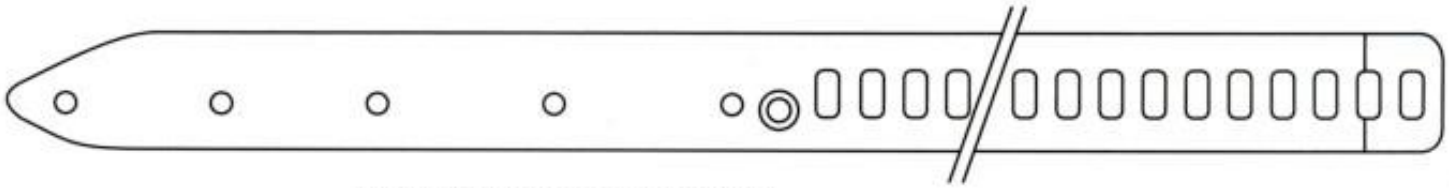

IMAMURA RAPIER TAPE SR107

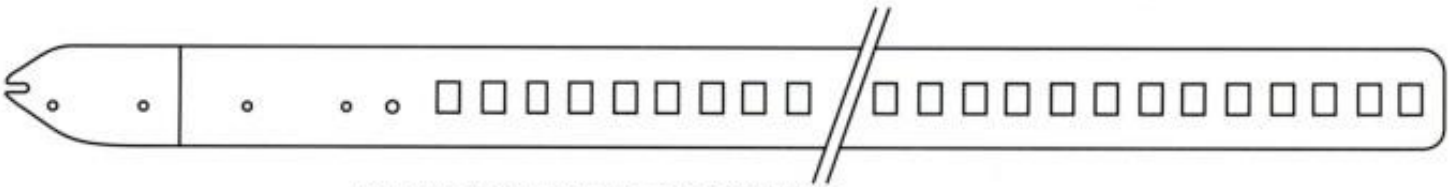

P. MAIA RAPIER TAPE TSL 500 LEFT

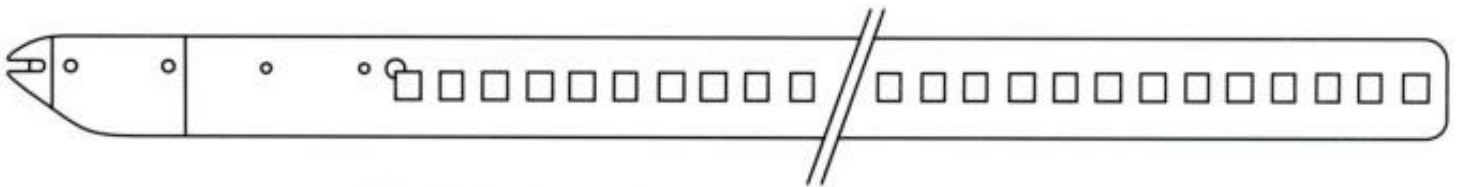

P. MAIA RAPIER TAPE TSL 500 RIGHT

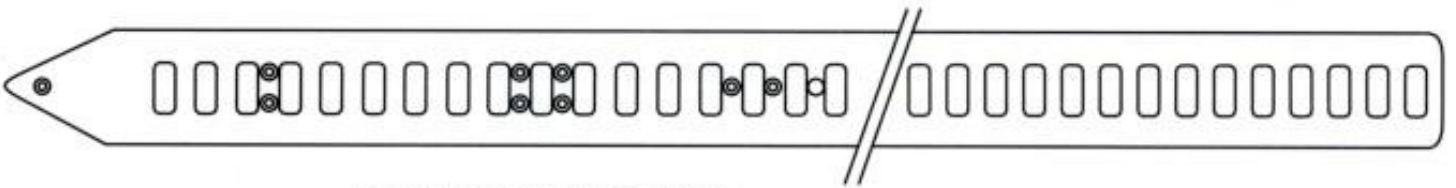

P. MAIA RAPIER TAPE ANCE

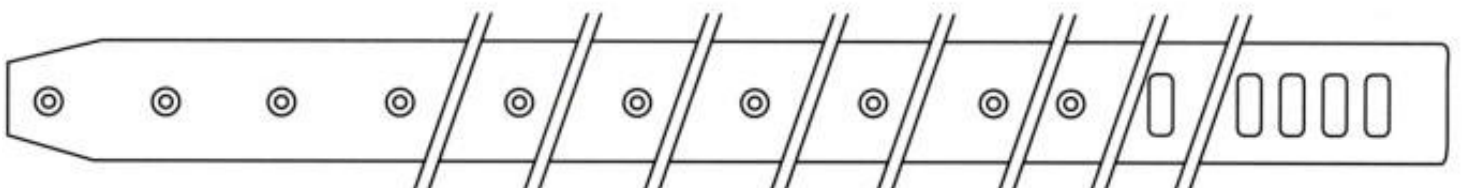

VAN DE WIELE RAPIER TAPE

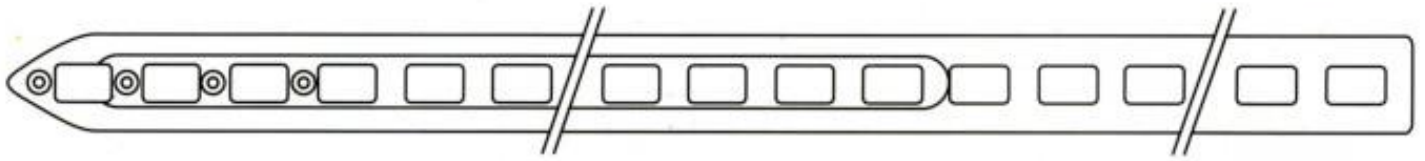

IWAMA PAPIER TAPE



IWAMA PAPIER TAPE MODEL RT500



TEXMACO PAPIER TAPE

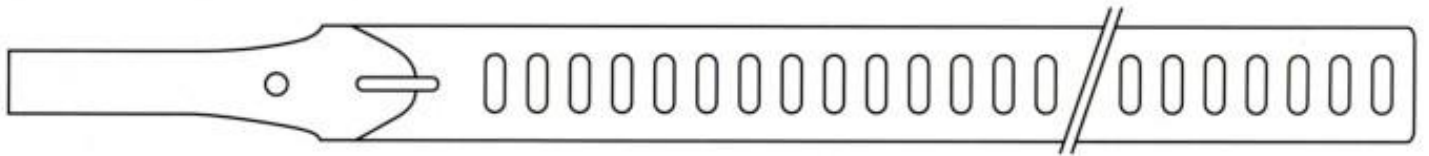

HIRAIWA PAPIER TAPE HUS



HIRAIWA PAPIER TAPE HAS

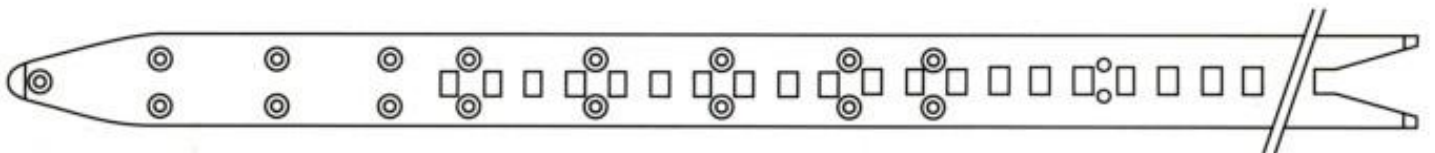

SNOECK PAPIER TAPE



733-LEFT

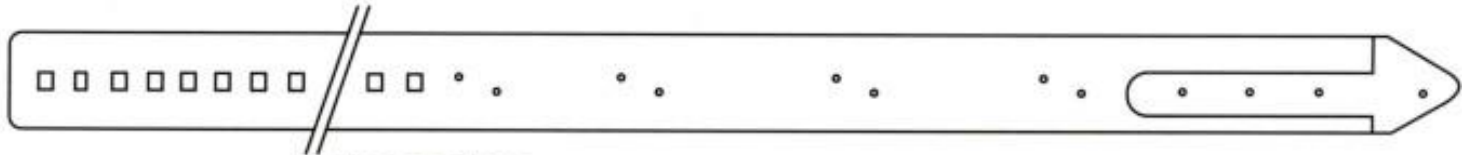

733-RIGHT

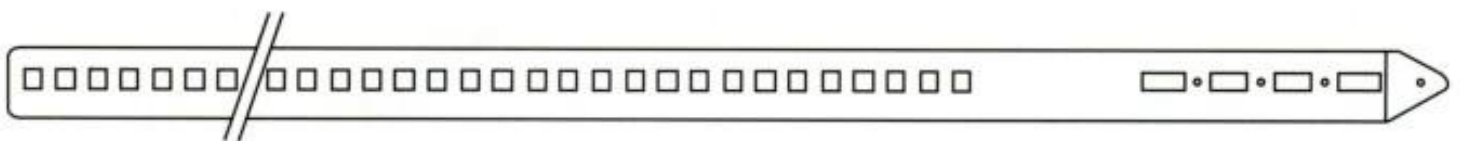
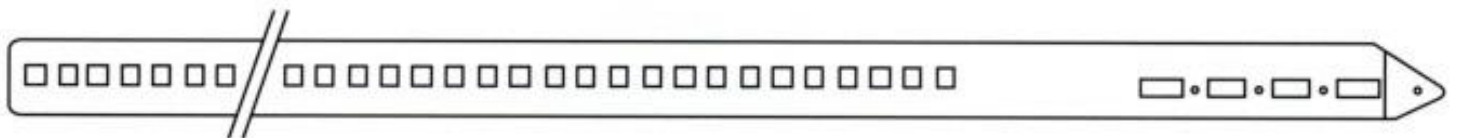
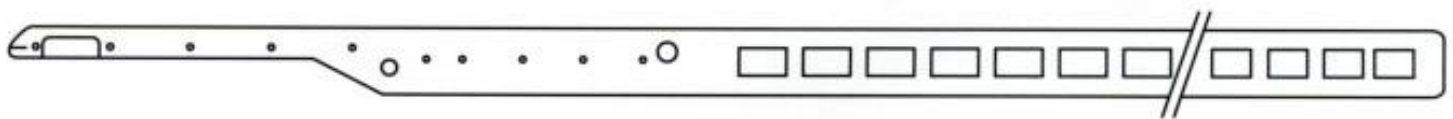
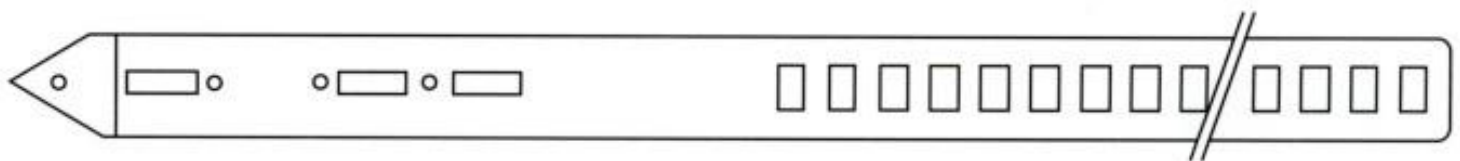
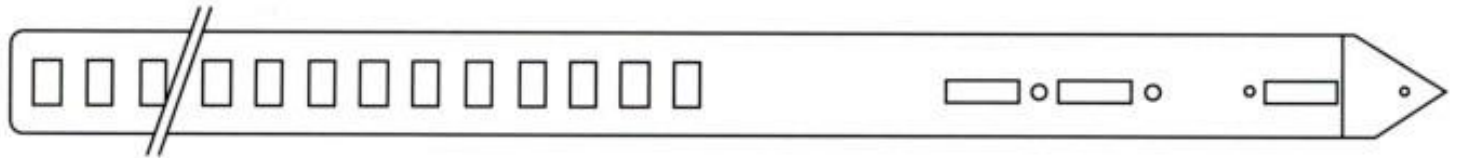

ASR61 大庆

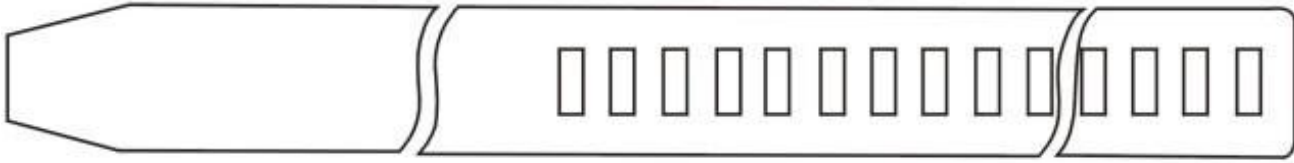

剑杆带长度 Tape Length	剑杆带厚度 Tape Thickness	备注 Remarks
L2976.0	W30.6mm	长度根据客户要求制造
L3365.2	W30.6mm	

YJ2003

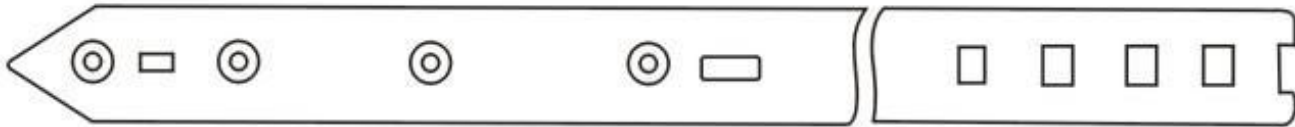

织布机门幅 Loom Space	剑杆带长度 Tape Length	备注 Remarks
H1900	L2446mm	左 / LEFT 右 / RIGHT
H2300	L2646mm	
H2800		



斯密特特种长度剑带 Somit Special Long Tape



织布机门幅 Loom Space	剑杆带长度 Tape Length	备注 Remarks
	L8700mm-L9900mm	

GA74特种长度剑带 GA74 Special Long Tape



织布机门幅 Loom Space	剑杆带长度 Tape Length	备注 Remarks
H6000mm-H6500mm	L5500mm	长度可定做到至10米
H6800mm-H7500mm	L6800mm	10M Can Be Customized

石川剑带 Ishikawa 1001 Tape



织布机门幅 Loom Space	剑杆带长度 Tape Length	备注 Remarks
	L2415mm	左/LEFT

织布机门幅 Loom Space	剑杆带长度 Tape Length	备注 Remarks
	L2498mm	右/RIGHT

石川碳纤剑带 Ishikawa 2001 Carbon Tape



织布机门幅 Loom Space	剑杆带长度 Tape Length	备注 Remarks
	L2740mm	
	L2750mm	

苏拉S400剑杆
SAURER S400 Carbon Rapier Tape



织布机门幅 Loom Space	剑杆带长度 Tape Length	备注 Remarks
H1850mm	L830mm	
H2050mm	L874mm	
H2250mm	L934mm	
H2450mm	L1020mm	
H2650mm	L1075mm	

SINOTEX NO.	ORIGINAL CODE	NAME & DESCRIPTION
SN02618-WZ	32/52E210L	AC/2S TAPE LH TYPE II LOOM WIDTH 210 TAPE L.1900MM
SN02619-WZ	32/52E330L	AC/2S TAPE LH TYPE II LOOM WIDTH 330 TAPE L.2450MM
SN02620-WZ	32/52E380L	AC/2S TAPE LH TYPE II LOOM WIDTH 380 TAPE L.2700MM
SN02621-WZ	32/52E420L	AC/2S TAPE LH TYPE II LOOM WIDTH 420 TAPE L.3100MM
SN02622-WZ	32/52E460L	AC/2S TAPE LH TYPE II LOOM WIDTH 460 TAPE L.3400MM
SN02623-WZ	32/52E210R	AC/2S TAPE RH TYPE II LOOM WIDTH 210 TAPE L.1900MM
SN02624-WZ	32/52E330R	AC/2S TAPE RH TYPE II LOOM WIDTH 330 TAPE L.2450MM
SN02625-WZ	32/52E380R	AC/2S TAPE RH TYPE II LOOM WIDTH 380 TAPE L.2700MM
SN02626-WZ	32/52E420R	AC/2S TAPE RH TYPE II LOOM WIDTH 420 TAPE L.3100MM
SN02627-WZ	32/52E460R	AC/2S TAPE RH TYPE II LOOM WIDTH 460 TAPE L.3400MM
SN02628-WZ	BA9932012G210L	AC/2S TPAE LH TYPE I LOOM WIDTH 210CM L.1900MM
SN02629-WZ	32/12G330L	AC/2S TPAE LH TYPE I LOOM WIDTH 330CM L.2450MM
SN02630-WZ	32/12G380L	AC/2S TPAE LH TYPE I LOOM WIDTH 380CM L.2700MM
SN02631-WZ	BA9932012G420L	AC/2S TPAE LH TYPE I LOOM WIDTH 420CM L.3100MM
SN02632-WZ	32/12G460L	AC/2S TPAE LH TYPE I LOOM WIDTH 460CM L.3400MM
SN02633-WZ	BA9932012G210R	AC/2S TPAE RH TYPE I LOOM WIDTH 210CM L.1900MM
SN02634-WZ	32/12G330R	AC/2S TPAE RH TYPE I LOOM WIDTH 330CM L.2450MM
SN02635-WZ	32/12G380R	AC/2S TPAE RH TYPE I LOOM WIDTH 380CM L.2700MM
SN02636-WZ	BA9932012G420R	AC/2S TPAE RH TYPE I LOOM WIDTH 420CM L.3100MM
SN02637-WZ	32/12G460R	AC/2S TPAE RH TYPE I LOOM WIDTH 460CM L.3400MM
SN02638-WZ	LEH70AA/N107B#2175C	ALPHA TAPE RH+LH LOOM WIDTH 170CM L.2175MM
SN02639-WZ	LEH70BA/N107B#2258C	ALPHA TAPE RH+LH LOOM WIDTH 190CM L.2258MM
SN02640-WZ	LEH70CA/N107B#2357C	ALPHA TAPE RH+LH LOOM WIDTH 210CM L.2357MM
SN02641-WZ	LEH70DA/N107B#2398C	ALPHA TAPE RH+LH LOOM WIDTH 220CM L.2398MM
SN02642-WZ	LEH70EA/N107B#2456C	ALPHA TAPE RH+LH LOOM WIDTH 230CM L.2456MM
SN02643-WZ	LEH70FA/N107B#2663C	ALPHA TAPE RH+LH LOOM WIDTH 260CM L.2663MM
SN02644-WZ	LEH70GA/N107B#2763C	ALPHA TAPE RH+LH LOOM WIDTH 280CM L.2763MM
SN02645-WZ	LEH70HA/N107B#2862C	ALPHA TAPE RH+LH LOOM WIDTH 300CM L.2862MM
SN02646-WZ	LEH70JA/N107B#2961C	ALPHA TAPE RH+LH LOOM WIDTH 320CM L.2961MM
SN02647-WZ	LEH70KA/N107B#3060C	ALPHA TAPE RH+LH LOOM WIDTH 340CM L.3060MM
SN02648-WZ	LEH70LA/N107B#3168C	ALPHA TAPE RH+LH LOOM WIDTH 360CM L.3168MM
SN02649-WZ	2798150A/2798152A	C401 TAPE ALSO FOR C301 P401 SP251 LOOM 160 L.1780
SN02650-WZ	2798102E/2798126A	C401 TAPE ALSO FOR C301 P401 SP251 LOOM 190 L.1920
SN02651-WZ	2798104E/2798128A	C401 TAPE ALSO FOR C301 P401 SP251 LOOM 210 L.2015

SN02652-WZ	2798106E/2798130A	C401 TAPE ALSO FOR C301 P401 SP251 LOOM 230 L.2110
SN02653-WZ	2798108E/2798132A	C401 TAPE ALSO FOR C301 P401 SP251 LOOM 260 L.2275
SN02654-WZ	2798110E/2798134A	C401 TAPE ALSO FOR C301 P401 SP251 LOOM 300 L.2515
SN02655-WZ	2798112E/2798136A	C401 TAPE ALSO FOR C301 P401 SP251 LOOM 320 L.2610
SN02656-WZ	2798114E/2798138A	C401 TAPE ALSO FOR C301 P401 SP251 LOOM 340 L.2705
SN02657-WZ	2798116E/2798140A	C401 TAPE ALSO FOR C301 P401 SP251 LOOM 360 L.2800
SN02658-WZ	2798118E/2798142A	C401 TAPE ALSO FOR C301 P401 SP251 LOOM 380 L.2895
SN02659-WZ	GTV160C/W	DORNIER GTV COMPLETE RAPIER ROD 160CM L.1120MM
SN02660-WZ	GTV170C/W	DORNIER GTV COMPLETE RAPIER ROD 170CM L.1170MM
SN02661-WZ	GTV180C/W	DORNIER GTV COMPLETE RAPIER ROD 180CM L.1220MM
SN02662-WZ	GTV190C/W	DORNIER GTV COMPLETE RAPIER ROD 190CM L.1270MM
SN02663-WZ	GTV200C/W	DORNIER GTV COMPLETE RAPIER ROD 200CM L.1320MM
SN02664-WZ	764747	DORNIER GTV COMPLETE RAPIER ROD 210CM L.1370MM
SN02665-WZ	GTV220C/W	DORNIER GTV COMPLETE RAPIER ROD 220CM L.1417MM
SN02666-WZ	GTV230C/W	DORNIER GTV COMPLETE RAPIER ROD 230CM L.1470MM
SN02667-WZ	700076	DORNIER GTV COMPLETE RAPIER ROD 240CM L.1520MM
SN02668-WZ	GTV250C/W	DORNIER GTV COMPLETE RAPIER ROD 250CM L.1570MM
SN02669-WZ	GTV260C/W	DORNIER GTV COMPLETE RAPIER ROD 260CM L.1620MM
SN02670-WZ	GTV270C/W	DORNIER GTV COMPLETE RAPIER ROD 270CM L.1670MM
SN02671-WZ	GTV280C/W	DORNIER GTV COMPLETE RAPIER ROD 280CM L.1720MM
SN02672-WZ	GTV290C/W	DORNIER GTV COMPLETE RAPIER ROD 290CM L.1770MM
SN02673-WZ	GTV300C/W	DORNIER GTV COMPLETE RAPIER ROD 300CM L.1820MM
SN02674-WZ	GTV320C/W	DORNIER GTV COMPLETE RAPIER ROD 320CM L.1920MM
SN02675-WZ	GTV330C/W	DORNIER GTV COMPLETE RAPIER ROD 330CM L.1970MM
SN02676-WZ	GTV340C/W	DORNIER GTV COMPLETE RAPIER ROD 340CM L.2020MM
SN02677-WZ	GTV350C/W	DORNIER GTV COMPLETE RAPIER ROD 350CM L.2070MM
SN02678-WZ	GTV360C/W	DORNIER GTV COMPLETE RAPIER ROD 360CM L.2120MM
SN02679-WZ	GTV380C/W	DORNIER GTV COMPLETE RAPIER ROD 380CM L.2220MM
SN02680-WZ	76004160	DORNIER HTV COMPLETE RAPIER ROD 160CM L.1050MM
SN02681-WZ	76004170	DORNIER HTV COMPLETE RAPIER ROD 170CM L.1100MM
SN02682-WZ	76004180	DORNIER HTV COMPLETE RAPIER ROD 180CM L.1150MM
SN02683-WZ	71562F	DORNIER HTV COMPLETE RAPIER ROD 190CM L.1200MM
SN02684-WZ	764745	DORNIER HTV COMPLETE RAPIER ROD 200CM L.1250MM
SN02685-WZ	764746	DORNIER HTV COMPLETE RAPIER ROD 210CM L.1300MM
SN02686-WZ	76004210	DORNIER HTV COMPLETE RAPIER ROD 220CM L.1350MM
SN02687-WZ	76004230	DORNIER HTV COMPLETE RAPIER ROD 230CM L.1400MM

SN02688-WZ	76004240	DORNIER HTV COMPLETE RAPIER ROD 240CM L.1450MM
SN02689-WZ	76004250	DORNIER HTV COMPLETE RAPIER ROD 250CM L.1500MM
SN02690-WZ	76004260	DORNIER HTV COMPLETE RAPIER ROD 260CM L.1550MM
SN02691-WZ	76004270	DORNIER HTV COMPLETE RAPIER ROD 270CM L.1600MM
SN02692-WZ	76004280	DORNIER HTV COMPLETE RAPIER ROD 280CM L.1650MM
SN02693-WZ	764755	DORNIER HTV COMPLETE RAPIER ROD 290CM L.1700MM
SN02694-WZ	764756	DORNIER HTV COMPLETE RAPIER ROD 300CM L.1750MM
SN02695-WZ	764757	DORNIER HTV COMPLETE RAPIER ROD 320CM L.1850MM
SN02696-WZ	764758	DORNIER HTV COMPLETE RAPIER ROD 330CM L.1900MM
SN02697-WZ	764759	DORNIER HTV COMPLETE RAPIER ROD 340CM L.1950MM
SN02698-WZ	764760	DORNIER HTV COMPLETE RAPIER ROD 350CM L.2000MM
SN02699-WZ	76004360	DORNIER HTV COMPLETE RAPIER ROD 360CM L.2050MM
SN02700-WZ	76005380	DORNIER HTV COMPLETE RAPIER ROD 380CM L.2150MM
SN02701-WZ	HTV190RR	DORNIER RACK ROD
SN02702-WZ	614332504	F2001 TAPE LEFT 140-160CM L.1542MM
SN02703-WZ	614332507	F2001 TAPE LEFT 170-190CM L.1660MM
SN02704-WZ	614332500	F2001 TAPE LEFT 200-220CM L.1810MM
SN02705-WZ	614332503	F2001 TAPE LEFT 230-250CM L.1975MM
SN02706-WZ	614332506	F2001 TAPE LEFT 260-280CM L.2132MM
SN02707-WZ	614332509	F2001 TAPE LEFT 290CM L.2179MM
SN02708-WZ	614330501	F2001 TAPE RIGHT 140-160CM L.1592MM
SN02709-WZ	614330503	F2001 TAPE RIGHT 170-190CM L.1675MM
SN02710-WZ	614330502	F2001 TAPE RIGHT 170-190CM L.1710MM
SN02711-WZ	614330504	F2001 TAPE RIGHT 200-220CM L.1860MM
SN02712-WZ	614330505	F2001 TAPE RIGHT 230-250CM L.2025MM
SN02713-WZ	614330506	F2001 TAPE RIGHT 260-280CM L.2182MM
SN02714-WZ	PNO580111700	FAST TAPE RH AND LH LOOM WIDTH 170 L.2510 MM
SN02715-WZ	PNO580111900	FAST TAPE RH AND LH LOOM WIDTH 190 L.2608 MM
SN02716-WZ	PNO580112000	FAST TAPE RH AND LH LOOM WIDTH 200 L.2650MM
SN02717-WZ	PNO580112200	FAST TAPE RH AND LH LOOM WIDTH 220 L.2748 MM
SN02718-WZ	PNO580112400	FAST TAPE RH AND LH LOOM WIDTH 240 L.2846 MM
SN02719-WZ	PNO580112600	FAST TAPE RH AND LH LOOM WIDTH 260 L.2944 MM
SN02720-WZ	PNO580112900	FAST TAPE RH AND LH LOOM WIDTH 290 L.3150 MM
SN02721-WZ	PNO580113200	FAST TAPE RH AND LH LOOM WIDTH 320 L.3355 MM
SN02722-WZ	PNO580113400	FAST TAPE RH AND LH LOOM WIDTH 340 L.3450 MM
SN02723-WZ	PNO580113600	FAST TAPE RH AND LH LOOM WIDTH 360 L.3550MM

SN02724-WZ	PBO580111700	FAST TAPE RH+LH 170CM L.2510MM
SN02725-WZ	PBO580111900	FAST TAPE RH+LH 190CM L.2608MM
SN02726-WZ	PBO580112000	FAST TAPE RH+LH 200CM L.2650MM
SN02727-WZ	PBO580112200	FAST TAPE RH+LH 220CM L.2748MM
SN02728-WZ	PBO580112400	FAST TAPE RH+LH 240CM L.2846MM
SN02729-WZ	PBO580112600	FAST TAPE RH+LH 260CM L.2944MM
SN02730-WZ	PBO580112900	FAST TAPE RH+LH 290CM L.3150MM
SN02731-WZ	PBO580113200	FAST TAPE RH+LH 320CM L.3355MM
SN02732-WZ	PBO580113400	FAST TAPE RH+LH 340CM L.3450MM
SN02733-WZ	PBO580113600	FAST TAPE RH+LH 360CM L.3550MM
SN02734-WZ	2357581692	G6100 TAPE 1.3MM LH 140-180CM L.1692MM
SN02735-WZ	2357581842	G6100 TAPE 1.3MM LH 190-210CM L.1842MM
SN02736-WZ	2357582042	G6100 TAPE 1.3MM LH 220-250CM L.2042MM
SN02737-WZ	2357582242	G6100 TAPE 1.3MM LH 260-290CM L.2242MM
SN02738-WZ	2357581573	G6100 TAPE 1.6MM LH 140-160CM L.1573MM
SN02739-WZ	2357581691	G6100 TAPE 1.6MM LH 170-190CM L.1691MM
SN02740-WZ	2357581841	G6100 TAPE 1.6MM LH 200-220CM L.1841MM
SN02741-WZ	2357582006	G6100 TAPE 1.6MM LH 230-250CM L.2006MM
SN02742-WZ	2357582163	G6100 TAPE 1.6MM LH 260-280CM L.2163MM
SN02743-WZ	235758160	G6100 TAPE 1.6MM RH 140-160CM L.1638MM
SN02744-WZ	235758190	G6100 TAPE 1.6MM RH 170-190CM L.1756MM
SN02745-WZ	235758220	G6100 TAPE 1.6MM RH 200-220CM L.1906MM
SN02746-WZ	235758250	G6100 TAPE 1.6MM RH 230-250CM L.2071MM
SN02747-WZ	235758280	G6100 TAPE 1.6MM RH 260-280CM L.2228MM
SN02748-WZ	2357581638	G6100 TAPE RH AND LH 1.3MM 140-160CM L.1638MM
SN02749-WZ	2357581756	G6100 TAPE RH AND LH 1.3MM 170-190CM L.1756MM
SN02750-WZ	2357581906	G6100 TAPE RH AND LH 1.3MM 200-220CM L.1906MM
SN02751-WZ	2357582071	G6100 TAPE RH AND LH 1.3MM 230-250CM L.2071MM
SN02752-WZ	2357582228	G6100 TAPE RH AND LH 1.3MM 260-280CM L.2228MM
SN02753-WZ	2357581663	G6100 TAPE RH AND LH 1.6MM 140-160CM L.1663MM
SN02754-WZ	2357581813	G6100 TAPE RH AND LH 1.6MM 170-190CM L.1813MM
SN02755-WZ	2357581963/614180502	G6100 TAPE RH AND LH 1.6MM 200-220CM L.1963MM
SN02756-WZ	2357582113	G6100 TAPE RH AND LH 1.6MM 230-250CM L.2113MM
SN02757-WZ	2357582263	G6100 TAPE RH AND LH 1.6MM 260-280CM L.2263MM
SN02758-WZ	2357582363	G6100 TAPE RH AND LH 1.6MM 290CM L.2363MM
SN02759-WZ	PQO148801900	G6200 TAPE RH AND LH 190CM L.1884MM

SN02760-WZ	PQO148802200	G6200 TAPE RH AND LH 220CM L.2134MM
SN02761-WZ	PQO148802600	G6200 TAPE RH AND LH 260CM L.2434MM
SN02762-WZ	PQO148802800	G6200 TAPE RH AND LH 280CM L.2684MM
SN02763-WZ	PQO14023-150	G6300 TAPE RH AND LH 150CM L.2630MM
SN02764-WZ	PQO14023-170	G6300 TAPE RH AND LH 170CM L.2532MM
SN02765-WZ	PQO14023-200	G6300 TAPE RH AND LH 200CM L.2672MM
SN02766-WZ	PQO14023-220	G6300 TAPE RH AND LH 220CM L.2770MM
SN02767-WZ	PQO14023-230	G6300 TAPE RH AND LH 230CM L.2822MM
SN02768-WZ	PQO14023-240	G6300 TAPE RH AND LH 240CM L.2863MM
SN02769-WZ	PQO14023-250	G6300 TAPE RH AND LH 250CM L.2556MM
SN02770-WZ	PQO14023-290	G6300 TAPE RH AND LH 290CM L.3172MM
SN02771-WZ	PQO14023-320	G6300 TAPE RH AND LH 320CM L.3377MM
SN02772-WZ	PQO14023-340	G6300 TAPE RH AND LH 340CM L.3472MM
SN02773-WZ	PQO14023-360	G6300 TAPE RH AND LH 360CM L.3572MM
SN02774-WZ	BA213736190	GAMMA TAPE LEFT 190 L1704MM
SN02775-WZ	BA213737200/BA206049220	GAMMA TAPE LEFT 220CM L.2580MM
SN02776-WZ	BA213738250	GAMMA TAPE LEFT 250CM L.2733
SN02777-WZ	BA213740340	GAMMA TAPE LEFT 340CM L.3177MM
SN02778-WZ	BA212270220o/BA206048220	GAMMA TAPE RH 220CM L.2609MM
SN02779-WZ	BA212271250o	GAMMA TAPE RH 250CM L.2761MM
SN02780-WZ	BA212273340o	GAMMA TAPE RH 340CM L. 3219MM
SN02781-WZ	BA206054340	GAMMA98 TAPE FOR 340
SN02782-WZ	BA206055340	GAMMA98 TAPE FOR 340
SN02783-WZ	BA204992190	GAMMA98 TAPE LH 190CM L.1732MM
SN02784-WZ	BA204993190	GAMMA98 TAPE RH 190CM L.1769MM
SN02785-WZ	BA204990	GAMMA98 TAPE RH+LH 190
SN02786-WZ	BA210453190	GAMMA99 TAPE RH 190
SN02787-WZ	BA212270220	GAMMA99 TAPE RIGHT 220CM L.2608MM
SN02788-WZ	BA212271250	GAMMA99 TAPE RIGHT 250CM L.2764
SN02789-WZ	BA212273340	GAMMA99 TAPE RIGHT 340CM L.3219MM
SN02790-WZ	BA219545190	GAMMAX TAPE LH 190CM L.1808MM
SN02791-WZ	BA219545210	GAMMAX TAPE LH 210CM L.2668MM
SN02792-WZ	BA219545220	GAMMAX TAPE LH 220CM L.2711MM
SN02793-WZ	BA219545230	GAMMAX TAPE LH 230CM L.2767MM
SN02794-WZ	BA219545250	GAMMAX TAPE LH 250CM L.2864MM
SN02795-WZ	BA219545300	GAMMAX TAPE LH 300CM L.3113MM

SN02796-WZ	BA219545320	GAMMAX TAPE LH 320CM L.3214MM
SN02797-WZ	BA219545340	GAMMAX TAPE LH 340CM L.3322MM
SN02798-WZ	BA219550190	GAMMAX TAPE RH 190CM L.1846MM
SN02799-WZ	BA219550220	GAMMAX TAPE RH 220CM L.2737MM
SN02800-WZ	BA219550250	GAMMAX TAPE RH 250CM L.2890MM
SN02801-WZ	BA219550300	GAMMAX TAPE RH 300CM L.3138MM
SN02802-WZ	BA219550340	GAMMAX TAPE RH 340CM L.3348MM
SN02803-WZ	BE81961	GTM LEFT GRIPPER+TAPE SUPPOT SET
SN02804-WZ	B88370-190	GTM TAPE 2 SERIES LH 190CM L.2215MM
SN02805-WZ	B88370-240	GTM TAPE 2 SERIES LH 240CM L. 2695MM
SN02806-WZ	B88370-280	GTM TAPE 2 SERIES LH 280CM L.3025MM
SN02807-WZ	BE80788-190	GTM TAPE LH LOOM WIDTH 190 TAPE L.2173MM
SN02808-WZ	BE80788-220	GTM TAPE LH LOOM WIDTH 220-240 TAPE L.2631MM
SN02809-WZ	BE80788-280	GTM TAPE LH LOOM WIDTH 280 TAPE L.2961MM
SN02810-WZ	BE80787-190/BE88363-190	GTM TAPE RH 190CM L.2161MM
SN02811-WZ	BE80787-220/BE88363-220	GTM TAPE RH 220-240CM L.2631MM
SN02812-WZ	BE80787-280/BE88363-280	GTM TAPE RH 280CM L.2948MM
SN02813-WZ	BE80787-190	GTM TAPE RH LOOM WIDTH 190 TAPE L.2161MM
SN02814-WZ	BE80787-220	GTM TAPE RH LOOM WIDTH 220-240 TAPE L.2631MM
SN02815-WZ	BE80787-280	GTM TAPE RH LOOM WIDTH 280 TAPE L.2948MM
SN02816-WZ	BE80788-190/BE88364-190	GTMA TAPE LH 190CM L.2161MM
SN02817-WZ	BE80788-220/BE88364-220	GTMA TAPE LH 220-240CM L. 2631MM
SN02818-WZ	BE80788-280/BE88364-280	GTMA TAPE LH 280CM L.2961MM
SN02819-WZ	B54160-190L	GTX TAPE LH 190CM L.2155MM
SN02820-WZ	B54160-190/B53043	GTX TAPE LH 190CM L.2218MM
SN02821-WZ	B54160-240	GTX TAPE LH 220-240CM L.2574MM
SN02822-WZ	B54160-280	GTX TAPE LH 280CM L.2904MM
SN02823-WZ	B54161-190/B55008	GTX TAPE RH 190CM L.2192MM
SN02824-WZ	B54161-240	GTX TAPE RH 220-240CM L.2611MM
SN02825-WZ	B54161-280	GTX TAPE RH 280CM L.2942MM
SN02826-WZ	B54141o-190	GTX TAPE RIGHT 14.5MM WIDTH 190CM L.2218MM
SN02827-WZ	B54141-190	GTX TAPE RIGHT 16.5MM 190CM L.2269MM
SN02828-WZ	B54141-240	GTX TAPE RIGHT 16.5MM 220-240CM L.2637MM
SN02829-WZ	B54141-280	GTX TAPE RIGHT 16.5MM 280CM L.2967MM
SN02830-WZ	B54141o-240	GTX TAPE RIGHT WIDTH 240-260CM L.2637MM 14. 5MM
SN02831-WZ	B54141o-280	GTX TAPE RIGHT WIDTH 280CM L.2967MM

SN02832-WZ	732-17-560-01	ISHIKAWA 2001 TAPE L=2748MM
SN02833-WZ	2798548A/2798631	LEONARDO TAPE LH (14MM) 170CM L.2230MM
SN02834-WZ	2798550A/2798632	LEONARDO TAPE LH (14MM) 190CM L.2330MM
SN02835-WZ	2798552A/2798633	LEONARDO TAPE LH (14MM) 210CM L.2430MM
SN02836-WZ	2798553/2798634	LEONARDO TAPE LH (14MM) 220CM L.2480MM
SN02837-WZ	2798554A/2798635	LEONARDO TAPE LH (14MM) 230CM L.2530MM
SN02838-WZ	2798556A/2798636	LEONARDO TAPE LH (14MM) 260CM L.2680MM
SN02839-WZ	2798558/2798637	LEONARDO TAPE LH (14MM) 280CM L.2780MM
SN02840-WZ	2798560A/2798638	LEONARDO TAPE LH (14MM) 300CM L.2910MM
SN02841-WZ	2798562A/2798639	LEONARDO TAPE LH (14MM) 320CM L.3010MM
SN02842-WZ	2798564A/2798640	LEONARDO TAPE LH (14MM) 340CM L.3110MM
SN02843-WZ	2798566A/2798641	LEONARDO TAPE LH (14MM) 360CM L.3210MM
SN02844-WZ	2798568A/2798642	LEONARDO TAPE LH (14MM) 380CM L.3310MM
SN02845-WZ	2798670/2798682	LEONARDO TAPE RH (14MM) 190CM L.2222MM
SN02846-WZ	2798671/2798683	LEONARDO TAPE RH (14MM) 210CM L.2322MM
SN02847-WZ	2798672/2798684	LEONARDO TAPE RH (14MM) 220CM L.2372MM
SN02848-WZ	2798673/2798685	LEONARDO TAPE RH (14MM) 230CM L.2422MM
SN02849-WZ	2798674/2798686	LEONARDO TAPE RH (14MM) 260CM L.2572MM
SN02850-WZ	2798675/2798687	LEONARDO TAPE RH (14MM) 280CM L.2672MM
SN02851-WZ	2798676/2798688	LEONARDO TAPE RH (14MM) 300CM L.2802MM
SN02852-WZ	2798677/2798689	LEONARDO TAPE RH (14MM) 320CM L.2902MM
SN02853-WZ	2798678/2798690	LEONARDO TAPE RH (14MM) 340CM L.3002MM
SN02854-WZ	2798679/2798691	LEONARDO TAPE RH (14MM) 360CM L.3102MM
SN02855-WZ	2798680/2798692	LEONARDO TAPE RH (14MM) 380CM L.3202MM
SN02856-WZ	2798570C/2798643B	LEONARDO TAPE RH WIDTH 13MM 170CM L.2140MM
SN02857-WZ	2798572C/2798644B	LEONARDO TAPE RH WIDTH 13MM 190CM L.2240MM
SN02858-WZ	2798574C/2798645B	LEONARDO TAPE RH WIDTH 13MM 210CM L.2430MM
SN02859-WZ	2798576C/2798646B	LEONARDO TAPE RH WIDTH 13MM 220CM L.2390MM
SN02860-WZ	2798578C/2798647B	LEONARDO TAPE RH WIDTH 13MM 230CM L.2440
SN02861-WZ	2798580C/2798648B	LEONARDO TAPE RH WIDTH 13MM 260CM L.2590MM
SN02862-WZ	2798582C/2798649B	LEONARDO TAPE RH WIDTH 13MM 280CM L.2690MM
SN02863-WZ	2798584C/2798650B	LEONARDO TAPE RH WIDTH 13MM 300CM L.2820MM
SN02864-WZ	2798586C/2798651B	LEONARDO TAPE RH WIDTH 13MM 320CM L.2920MM
SN02865-WZ	2798588C/2798652B	LEONARDO TAPE RH WIDTH 13MM 340CM L.3020MM
SN02866-WZ	2798590C/2798653B	LEONARDO TAPE RH WIDTH 13MM 360CM L.3120MM
SN02867-WZ	2798592C/2798654B	LEONARDO TAPE RH WIDTH 13MM 380CM L.3220MM

SN02868-WZ	2798669/2798681	LEONARDO TAPE RH (14MM) 1700CM L.2122MM
SN02869-WZ	631108/631109	MULLER I TAPE
SN02870-WZ	631110/631111	MULLER II TAPE
SN02871-WZ	6712244307	MULLER LEFT TAPE FOR GRIPPER MBJ3
SN02872-WZ	6712264007	MULLER RIGHT TAPE FOR GRIPPER MBJ3
SN02873-WZ	621191	MULLER TAPE
SN02874-WZ	621216	MULLER TAPE II LEFT L.952*16*2.4MM
SN02875-WZ	621192	MULLER TAPE II RIGHT L.947*16*2.4MM
SN02876-WZ	621571	MULLER TAPE III LEFT L.1092MM
SN02877-WZ	621572	MULLER TAPE III RIGHT L.1077MM
SN02878-WZ	621675	MULLER TAPE III-1 RIGHT L.1077MM
SN02879-WZ	2798370C	P1001 TAPE HEAD CHANGEABLE LH 160CM L.2130MM
SN02880-WZ	2798371C	P1001 TAPE HEAD CHANGEABLE LH 190 L.2280MM
SN02881-WZ	2798372C	P1001 TAPE HEAD CHANGEABLE LH 210CM L.2380MM
SN02882-WZ	2798373C	P1001 TAPE HEAD CHANGEABLE LH 230CM L.2480MM
SN02883-WZ	2798374C	P1001 TAPE HEAD CHANGEABLE LH 260CM L.2630MM
SN02884-WZ	2798375C	P1001 TAPE HEAD CHANGEABLE LH 280CM L.2730MM
SN02885-WZ	2798376C	P1001 TAPE HEAD CHANGEABLE LH 300CM L.2860MM
SN02886-WZ	2798377C	P1001 TAPE HEAD CHANGEABLE LH 320CM L.2960MM
SN02887-WZ	2798378C	P1001 TAPE HEAD CHANGEABLE LH 340CM L.3060MM
SN02888-WZ	2798379C	P1001 TAPE HEAD CHANGEABLE LH 360CM L.3160MM
SN02889-WZ	2798380C	P1001 TAPE HEAD CHANGEABLE LH 380CM L.3260MM
SN02890-WZ	2798381B	P1001 TAPE HEAD CHANGEABLE RH 160CM L.1945MM
SN02891-WZ	2798382B	P1001 TAPE HEAD CHANGEABLE RH 190CM L.2095MM
SN02892-WZ	2798383B	P1001 TAPE HEAD CHANGEABLE RH 210CM L.2195MM
SN02893-WZ	2798384B	P1001 TAPE HEAD CHANGEABLE RH 230CM L.2295MM
SN02894-WZ	2798385B	P1001 TAPE HEAD CHANGEABLE RH 260CM L.2445MM
SN02895-WZ	2798386B	P1001 TAPE HEAD CHANGEABLE RH 280CM L.2545MM
SN02896-WZ	2798387B	P1001 TAPE HEAD CHANGEABLE RH 300CM L.2675MM
SN02897-WZ	2798388B	P1001 TAPE HEAD CHANGEABLE RH 320CM L.2775MM
SN02898-WZ	2798389B	P1001 TAPE HEAD CHANGEABLE RH 340CM L.2875MM
SN02899-WZ	2798390B	P1001 TAPE HEAD CHANGEABLE RH 360CM L.2975MM
SN02900-WZ	2798391B	P1001 TAPE HEAD CHANGEABLE RH 380CM L.3075MM
SN02901-WZ	2508096	P1001 TAPE LEFT POINT PROTECTION, THICKNESS 4MM
SN02902-WZ	2798220/2798592	P1001 TAPE LH 160CM L.2190MM
SN02903-WZ	2798221/2798594	P1001 TAPE LH 190CM L.2340MM

SN02904-WZ	2798222/2798596	P1001 TAPE LH 210CM L.2440MM
SN02905-WZ	2798223/2798598	P1001 TAPE LH 230CM L.2540MM
SN02906-WZ	2798224/2798600	P1001 TAPE LH 260CM L.2690MM
SN02907-WZ	2798225/2798602	P1001 TAPE LH 300CM L.2920MM
SN02908-WZ	2798226/2798604	P1001 TAPE LH 320CM L.3020MM
SN02909-WZ	2798227/2798606	P1001 TAPE LH 340CM L.3120MM
SN02910-WZ	2798228/2798608	P1001 TAPE LH 360CM L.3220MM
SN02911-WZ	2798229/2798610	P1001 TAPE LH 380CM L.3320MM
SN02912-WZ	2798230/2798612	P1001 TAPE RH 160CM L.2030MM
SN02913-WZ	2798231/2798614	P1001 TAPE RH 190CM L.2180MM
SN02914-WZ	2798232/2798616	P1001 TAPE RH 210CM L.2280MM
SN02915-WZ	2798233/2798618	P1001 TAPE RH 230CM L.2380M
SN02916-WZ	2798234/2798620	P1001 TAPE RH 260CM L.2530MM
SN02917-WZ	2798235/2798622	P1001 TAPE RH 300CM L.2760MM
SN02918-WZ	2798236/2798624	P1001 TAPE RH 320CM L.2860MM
SN02919-WZ	2798237/2798626	P1001 TAPE RH 340CM L.2960MM
SN02920-WZ	2798238/2798628	P1001 TAPE RH 360CM L.3060MM
SN02921-WZ	2798239/2798630	P1001 TAPE RH 380CM L.3160MM
SN02922-WZ	MC2508100	P1001 TAPE RIGHT POINT PROTECTION, THICKNESS 4MM
SN02923-WZ	2501215	PANTER TAPE
SN02924-WZ	B71523-200	PGW TAPE LEFT 10 HOLES FOR GRIPPER 200CM L1478.4MM
SN02925-WZ	B71523-245	PGW TAPE LEFT 10 HOLES FOR GRIPPER 245CM L.1707MM
SN02926-WZ	B71523-282	PGW TAPE LEFT 10 HOLES FOR GRIPPER 282CM L1897.5MM
SN02927-WZ	B71523-300	PGW TAPE LEFT 10 HOLES FOR GRIPPER 300CM L1986.5MM
SN02928-WZ	B76001-200	PGW TAPE LH+RH 18 HOLES 190-200CM L.1519.4
SN02929-WZ	B76001-245	PGW TAPE LH+RH 18 HOLES 245CM L.1748.0
SN02930-WZ	B76001-282	PGW TAPE LH+RH 18 HOLES 282CM L.1938.5
SN02931-WZ	B76001-300	PGW TAPE LH+RH 18 HOLES 300CM L.2027.4
SN02932-WZ	B76001-350	PGW TAPE LH+RH 18 HOLES 350CM L.2281.4
SN02933-WZ	B74214-200	PGW TAPE RIGHT WITH 12HOLES 200CM L.1519.4
SN02934-WZ	B74214-245	PGW TAPE RIGHT WITH 12HOLES 245CM L.1748.9
SN02935-WZ	B74214-282	PGW TAPE RIGHT WITH 12HOLES 282CM L.1938.5
SN02936-WZ	B74214-300	PGW TAPE RIGHT WITH 12HOLES 300CM L.2027.4
SN02937-WZ	B74214-350	PGW TAPE RIGHT WITH 12HOLES 350CM L.2281.9
SN02938-WZ	847049	SAURER400-185 CARBON INER ROD
SN02939-WZ	847483	SAURER400-185 METAL PROFILE FOR CARBON ROD

SN02940-WZ	847507/847 507	SAURER400-185 METAL PROFILE FOR CARBON ROD
SN02941-WZ	847484	SAURER400-205 METAL PROFILE FOR CARBON ROD
SN02942-WZ	847508	SAURER400-205 METAL PROFILE FOR CARBON ROD
SN02943-WZ	847486	SAURER400-245 CARBON INER ROAD L.1024MM
SN02944-WZ	EH7014C/EH7028B	SM93 SM92 TAPE LH+RH 165CM L.1891MM
SN02945-WZ	EH7015C/EH7029B	SM93 SM92 TAPE LH+RH 190CM L.2001MM
SN02946-WZ	EH7016C/EH7030B	SM93 SM92 TAPE LH+RH 210-220CM L.2155MM
SN02947-WZ	EH7017C/EH7031B	SM93 SM92 TAPE LH+RH 230CM L.2199MM
SN02948-WZ	EH7018C/EH7032B	SM93 SM92 TAPE LH+RH 260CM L.2418MM
SN02949-WZ	EH7019C/EH7033B	SM93 SM92 TAPE LH+RH 280CM L.2528MM
SN02950-WZ	EH7020C/EH7034B	SM93 SM92 TAPE LH+RH 320CM L.2725MM
SN02951-WZ	EH7021C/EH7035B	SM93 SM92 TAPE LH+RH 340CM L.2813MM
SN02952-WZ	EH7022C/EH7036B	SM93 SM92 TAPE LH+RH 360CM L.2923MM
SN02953-WZ	EH7023C/EH7037B	SM93 SM92 TAPE LH+RH 380CM L.3021MM
SN02954-WZ	EH7024C/EH7038B	SM93 SM92 TAPE LH+RH 420CM L.3218MM
SN02955-WZ	EH7025C/EH7039B	SM93 SM92 TAPE LH+RH 460CM L.3406MM
SN02956-WZ	EH7054A/EH7066A	SM93 SM92 TAPE RH+LH 165CM L.1892MM
SN02957-WZ	EH7055A/EH7067A	SM93 SM92 TAPE RH+LH 190CM L.2000MM
SN02958-WZ	EH7056A/EH7068A	SM93 SM92 TAPE RH+LH 210CM L.2154MM
SN02959-WZ	EH7057A/EH7069AV	SM93 SM92 TAPE RH+LH 230CM L.2198MM
SN02960-WZ	EH7058A/EH7070A	SM93 SM92 TAPE RH+LH 260CM L.2417MM
SN02961-WZ	EH7059A/EH7071B	SM93 SM92 TAPE RH+LH 280CM L.2527MM
SN02962-WZ	EH7060B/EH7072B	SM93 SM92 TAPE RH+LH 320CM L.2724MM
SN02963-WZ	EH7061B/EH7073B	SM93 SM92 TAPE RH+LH 340CM L.2812MM
SN02964-WZ	EH7062B/EH7074B	SM93 SM92 TAPE RH+LH 360CM L.2922MM
SN02965-WZ	EH7063B/EH7075B	SM93 SM92 TAPE RH+LH 380CM L.3020MM
SN02966-WZ	EH7064B/EH7076B	SM93 SM92 TAPE RH+LH 420CM L.3219MM
SN02967-WZ	EH7065B/EH7077B	SM93 SM92 TAPE RH+LH 460CM L.3405MM
SN02968-WZ	BPE112BF/N1101956	ST880 TAPE RH+LH 190CM L.1956MM
SN02969-WZ	BPE113BV	ST880 TAPE RH+LH 220CM L.2044MM
SN02970-WZ	BPE114BR	ST880 TAPE RH+LH 230CM L.2154MM
SN02971-WZ	BPE115BD	ST880 TAPE RH+LH 260CM L.2395MM
SN02972-WZ	BPE116BJ	ST880 TAPE RH+LH 310CM L.2593MM
SN02973-WZ	BPE117BS	ST880 TAPE RH+LH 340CM L.2790MM
SN02974-WZ	BPE118BE	ST880 TAPE RH+LH 360CM L.2900MM
SN02975-WZ	HH7025B/HH7049A	THEMA TAPE LH+RH 165CM L.2099MM

SN02976-WZ	HH7026B/HH7050A	THEMA TAPE LH+RH 190CM L.2209MM
SN02977-WZ	HH7027B/HH7051A	THEMA TAPE LH+RH 210-220CM L.2362MM
SN02978-WZ	HH7028B/HH7052A	THEMA TAPE LH+RH 230CM L.2418MM
SN02979-WZ	HH7029B/HH7053AL	THEMA TAPE LH+RH 260CM L.2626MM
SN02980-WZ	HH7030B/HH7054A	THEMA TAPE LH+RH 280CM L.2725MM
SN02981-WZ	HH7031BW/HH7055AA	THEMA TAPE LH+RH 300-320CM L.2923MM
SN02982-WZ	HH7032B/HH7056A	THEMA TAPE LH+RH 340CM L.3021MM
SN02983-WZ	HH7033BL/HH7057A	THEMA TAPE LH+RH 360CM L.3130MM
SN02984-WZ	HH7034B/HH7058A	THEMA TAPE LH+RH 380CM L.3218MM
SN02985-WZ	HH7035B/HH7059A	THEMA TAPE LH+RH 400CM L.3406MM
SN02986-WZ	HH7036B/HH7060A	THEMA TAPE LH+RH 420CM L.3525MM
SN02987-WZ	HH7037B/HH7061A	THEMA TAPE LH+RH 460CM L.3745MM
SN02988-WZ	HH7160A	THEMA11 ECECL/MFG LH 165CM L.1980MM
SN02989-WZ	HH7161A	THEMA11 ECECL/MFG LH 190CM L.2104MM
SN02990-WZ	HH7162A	THEMA11 ECECL/MFG LH 210CM L.2203MM
SN02991-WZ	HH7163A	THEMA11 ECECL/MFG LH 220CM L.2253MM
SN02992-WZ	HH7164A	THEMA11 ECECL/MFG LH 230CM L.2303MM
SN02993-WZ	HH7165A	THEMA11 ECECL/MFG LH 260CM L.2515MM
SN02994-WZ	HH7166A	THEMA11 ECECL/MFG LH 280CM L.2616MM
SN02995-WZ	HH7167A	THEMA11 ECECL/MFG LH 300CM L.2715MM
SN02996-WZ	HH7168A	THEMA11 ECECL/MFG LH 320CM L.2814MM
SN02997-WZ	HH7169A	THEMA11 ECECL/MFG LH 340CM L.2913MM
SN02998-WZ	HH7170A	THEMA11 ECECL/MFG LH 360CM L.3012MM
SN02999-WZ	HH7171A	THEMA11 ECECL/MFG LH 380CM L.3119MM
SN03000-WZ	HH7172A	THEMA11 ECECL/MFG LH 400CM L.3218MM
SN03001-WZ	HH7146A	THEMA11 EXCEL/MFG RH 165CM L.1980 MM
SN03002-WZ	HH7147A	THEMA11 EXCEL/MFG RH 190CM L.2104 MM
SN03003-WZ	HH7148A	THEMA11 EXCEL/MFG RH 210CM L.2203 MM
SN03004-WZ	HH7149A	THEMA11 EXCEL/MFG RH 220CM L.2253 MM
SN03005-WZ	HH7150A	THEMA11 EXCEL/MFG RH 230CM L.2303 MM
SN03006-WZ	HH7151A	THEMA11 EXCEL/MFG RH 260CM L.2517MM
SN03007-WZ	HH7152A	THEMA11 EXCEL/MFG RH 280CM L.2616MM
SN03008-WZ	HH7153A	THEMA11 EXCEL/MFG RH 300CM L.2715 MM
SN03009-WZ	HH7154A	THEMA11 EXCEL/MFG RH 320CM L.2814 MM
SN03010-WZ	HH7155A	THEMA11 EXCEL/MFG RH 340CM L.2913 MM
SN03011-WZ	HH7156A	THEMA11 EXCEL/MFG RH 360CM L.3012 MM

SN03012-WZ	HH7157A	THEMA11 EXCEL/MFG RH 380CM L.3119 MM
SN03013-WZ	HH7158A	THEMA11 EXCEL/MFG RH 400CM L.3218 MM
SN03014-WZ	HH7012B/HH7062AY	THEMA11 TAPE LH+RH 165CM L.2056MM
SN03015-WZ	HH7013B/HH7063AA	THEMA11 TAPE LH+RH 190CM L.2187MM
SN03016-WZ	HH7086A/HH7087A/N1072287	THEMA11 TAPE LH+RH 210CM L.2287MM
SN03017-WZ	HH7014B/HH7064AM/HH7014A	THEMA11 TAPE LH+RH 220CM L.2330MM
SN03018-WZ	HH7015B/HH7065AB	THEMA11 TAPE LH+RH 230CM L.2385MM
SN03019-WZ	HH7042A/HH7066AP/N1072593	THEMA11 TAPE LH+RH 260CM L.2593MM
SN03020-WZ	HH7043A/HH7067AH	THEMA11 TAPE LH+RH 280CM L.2692MM
SN03021-WZ	HH7088A/HH7089AS	THEMA11 TAPE LH+RH 300CM L.2791MM
SN03022-WZ	HH7044A/HH7068AT/N1072890	THEMA11 TAPE LH+RH 320CM L.2890MM
SN03023-WZ	HH7045A/HH7069AG/N1072988	THEMA11 TAPE LH+RH 340CM L.2988MM
SN03024-WZ	HH7046A/HH7070AU/N1073098	THEMA11 TAPE LH+RH 360CM L.3098MM
SN03025-WZ	HH7047A/HH7071AF/N1073197	THEMA11 TAPE LH+RH 380CM L.3197MM
SN03026-WZ	HH7048A/HH7072AV	THEMA11 TAPE LH+RH 400CM L.3295MM
SN03027-WZ	HH7104A	THEMA11E TAPE LH LOOM 132 L.1963MM
SN03028-WZ	HH7091A	THEMA11E TAPE LH LOOM 165 L.2128MM
SN03029-WZ	HH7092A	THEMA11E TAPE LH LOOM 190 L.2252MM
SN03030-WZ	HH7093A	THEMA11E TAPE LH LOOM 210 L.2351MM
SN03031-WZ	HH7094A	THEMA11E TAPE LH LOOM 220 L.2400MM
SN03032-WZ	HH7095A	THEMA11E TAPE LH LOOM 230 L.2450MM
SN03033-WZ	HH7096A	THEMA11E TAPE LH LOOM 260 L.2664MM
SN03034-WZ	HH7097A	THEMA11E TAPE LH LOOM 280 L.2763MM
SN03035-WZ	HH7098A	THEMA11E TAPE LH LOOM 300 L.2862MM
SN03036-WZ	HH7099A	THEMA11E TAPE LH LOOM 320 L.2961MM
SN03037-WZ	HH7100A	THEMA11E TAPE LH LOOM 340 L.3060MM
SN03038-WZ	HH7101A	THEMA11E TAPE LH LOOM 360 L.3159MM
SN03039-WZ	HH7102A	THEMA11E TAPE LH LOOM 380 L.3267MM
SN03040-WZ	HH7103A	THEMA11E TAPE LH LOOM 400 L.3366MM
SN03041-WZ	HNYA187B	THEMA11E TAPE RH LOOM 132 L.1964MM
SN03042-WZ	HH7104C	THEMA11E TAPE RH LOOM 165 L.2128MM
SN03043-WZ	HH7105C	THEMA11E TAPE RH LOOM 190 L.2252MM
SN03044-WZ	HH7106C	THEMA11E TAPE RH LOOM 210 L.2351MM
SN03045-WZ	HH7107C	THEMA11E TAPE RH LOOM 220 L.2400MM
SN03046-WZ	HH7108C	THEMA11E TAPE RH LOOM 230 L.2450MM
SN03047-WZ	HH7109C	THEMA11E TAPE RH LOOM 260 L.2664MM

SN03048-WZ	HH7110C	THEMA11E TAPE RH LOOM 280 L.2763MM
SN03049-WZ	HH7111C	THEMA11E TAPE RH LOOM 300 L.2862MM
SN03050-WZ	HH7112C	THEMA11E TAPE RH LOOM 320 L.2961MM
SN03051-WZ	HH7113C	THEMA11E TAPE RH LOOM 340 L.3060MM
SN03052-WZ	HH7114C	THEMA11E TAPE RH LOOM 360 L.3159MM
SN03053-WZ	HH7115C	THEMA11E TAPE RH LOOM 380 L.3267MM
SN03054-WZ	HH7116C	THEMA11E TAPE RH LOOM 400 L.3366MM
SN03055-WZ	PAZ63500-210	TP300 TAPE RH AND LH LOOM 210 L.2010MM
SN03056-WZ	PAZ63500-250	TP300 TAPE RH AND LH LOOM 250 L.2213MM
SN03057-WZ	PAZ63500-330	TP300 TAPE RH AND LH LOOM 330 L.2620MM
SN03058-WZ	PAZ63500-360	TP300 TAPE RH AND LH LOOM 360 L.2766MM
SN03059-WZ	PAZ63500-410	TP300 TAPE RH AND LH LOOM 410 L.3016MM
SN03060-WZ	PBZ58006	TP300-TP400 TAPE LOOM WIDTH 190 L.1620MM
SN03061-WZ	PBZ58007	TP300-TP400 TAPE LOOM WIDTH 210 L.1720MM
SN03062-WZ	PBZ58008	TP300-TP400 TAPE LOOM WIDTH 230 L.1818MM
SN03063-WZ	PBZ58009	TP300-TP400 TAPE LOOM WIDTH 250 L.1916MM
SN03064-WZ	PBZ58010	TP300-TP400 TAPE LOOM WIDTH 290 L.2120MM
SN03065-WZ	PBZ58011	TP300-TP400 TAPE LOOM WIDTH 330 L.2316MM
SN03066-WZ	PBZ58012	TP300-TP400 TAPE LOOM WIDTH 360 L.2468MM
SN03067-WZ	PBZ58090	TP300-TP400 TAPE LOOM WIDTH 410 L.3000MM
SN03068-WZ	PBZ58093	TP300-TP400 TAPE LOOM WIDTH 550 L.3868MM
SN03069-WZ	PBZ58060	TP400 TAPE RH AND LH LOOM 200 L.1655MM
SN03070-WZ	PBZ58061	TP422 TAPE RH AND LH LOOM 220 L.1752MM
SN03071-WZ	PBZ58062	TP424 TAPE RH AND LH LOOM 240 L.1850MM
SN03072-WZ	PBZ58063	TP426 TAPE RH AND LEFT LOOM 260 L.1948MM
SN03073-WZ	PBZ58064	TP429 TAPE RH AND LH LOOM 390 L.2154MM
SN03074-WZ	PBZ58065	TP433 TAPE RH AND LEFT LOOM 330 L.2348MM
SN03075-WZ	PBZ58066	TP436 TAPE RH AND LEFT LOOM 360 L.2500MM
SN03076-WZ	PBZ58077	TP441 TAPE RH AND LH LOOM 410 L.2748MM
SN03077-WZ	PBZ581112000	TP520 TAPE LH AND RH LOOM 200 L.2200MM
SN03078-WZ	PBZ581252000	TP520 TAPE RH AND LH LOOM 200 L.2075MM
SN03079-WZ	PBZ581252200	TP522 TAPE RH AND LH LOOM 220 L.2185MM
SN03080-WZ	PBZ581112200	TP522 TAPE RH AND LH LOOM 220 L.2310MM
SN03081-WZ	PBZ581252400	TP524 TAPE RH AND LH LOOM 240 L.2293MM
SN03082-WZ	PBZ581112400	TP524 TAPE RH AND LH LOOM 240 L.2418MM
SN03083-WZ	PBZ581252600	TP526 TAPE RH AND LH LOOM 260 L.2380MM

SN03084-WZ	PBZ581112600	TP526 TAPE RH AND LH LOOM 260 L.2505MM
SN03085-WZ	PBZ581252900	TP529 TAPE RH AND LH LOOM 290 L.2575MM
SN03086-WZ	PBZ581112900	TP529 TAPE RH AND LH LOOM 290 L.2700MM
SN03087-WZ	PBZ581253300	TP533 TAPE RH AND LH LOOM 330 L.2770MM
SN03088-WZ	PBZ581113300	TP533 TAPE RH AND LH LOOM 330 L.2895MM
SN03089-WZ	PBZ581253600	TP536 TAPE RH AND LH LOOM 360 L.2922MM
SN03090-WZ	PBZ581113600	TP536 TAPE RH AND LH LOOM 360 L.3047MM
SN03091-WZ	PBZ581253800	TP538 TAPE RH AND LH LOOM 380 L.3140MM
SN03092-WZ	PBZ581113800	TP538 TAPE RH AND LH LOOM 380 L.3265MM
SN03093-WZ	PBZ581254400	TP544 TAPE RH AND LH LOOM 440 L.3487MM
SN03094-WZ	PBZ581114400	TP544 TAPE RH AND LH LOOM 440 L.3612MM
SN03095-WZ	PBZ581142000	TP600 TAPE RH AND LH LOOM 200 L.2200MM
SN03096-WZ	PBZ581142200	TP600 TAPE RH AND LH LOOM 220 L.2310MM
SN03097-WZ	PBZ581142400	TP600 TAPE RH AND LH LOOM 240 L.2418MM
SN03098-WZ	PBZ581142600	TP600 TAPE RH AND LH LOOM 260 L.2505MM
SN03099-WZ	PBZ581142900	TP600 TAPE RH AND LH LOOM 290 L.2700MM
SN03100-WZ	PBZ581143300	TP600 TAPE RH AND LH LOOM 330 L.2895MM
SN03101-WZ	PBZ581143600	TP600 TAPE RH AND LH LOOM 360 L.3047MM
SN03102-WZ	PBZ581143800	TP600 TAPE RH AND LH LOOM 380 L.3265MM
SN03103-WZ	PBZ581144400	TP600 TAPE RH AND LH LOOM 440 L.3612MM
SN03104-WZ	PBZ581242000	TP620 TAPE RH AND LH LOOM 200 L.2075MM
SN03105-WZ	PBZ581242200	TP622 TAPE RH AND LH LOOM 220 L.2185MM
SN03106-WZ	PBZ581242400	TP624 TAPE RH AND LH LOOM 240 L.2293MM
SN03107-WZ	PBZ581242600	TP626 TAPE RH AND LH LOOM 260 L.2380MM
SN03108-WZ	PBZ581242900	TP629 TAPE RH AND LH LOOM 290 L.2575MM
SN03109-WZ	PBZ581243300	TP633 TAPE RH AND LH LOOM 330 L.2770MM
SN03110-WZ	PBZ581243600	TP636 TAPE RH AND LH LOOM 360 L.2922MM
SN03111-WZ	PBZ581243800	TP638 TAPE RH AND LH LOOM 380 L.3140MM
SN03112-WZ	PBZ581244400	TP644 TAPE RH AND LH LOOM 440 L.3487MM
SN03113-WZ	EPE073AC	UV770 TAPE RH+LH THICKNESS 2.5MM LOOM 190 L.1920MM
SN03114-WZ	EPE074AY	UV770 TAPE RH+LH THICKNESS 2.5MM LOOM 210 L.2020MM
SN03115-WZ	EPE075AT	UV770 TAPE RH+LH THICKNESS 2.5MM LOOM 230 L.2120MM
SN03116-WZ	EPE076AA	UV770 TAPE RH+LH THICKNESS 2.5MM LOOM 260 L.2360MM
SN03117-WZ	EPE077AM	UV770 TAPE RH+LH THICKNESS 2.5MM LOOM 300 L.2560MM
SN03118-WZ	EPE078AP	UV770 TAPE RH+LH THICKNESS 2.5MM LOOM 340 L.2760MM
SN03119-WZ	EPE079AH	UV770 TAPE RH+LH THICKNESS 2.5MM LOOM 360 L.2880MM

SN03120-WZ	EPE031BP	UV770 TAPE RH+LH THICKNESS 3MM LOOM 180 L.1690 MM
SN03121-WZ	EPE032BH	UV770 TAPE RH+LH THICKNESS 3MM LOOM 210 L.1790MM
SN03122-WZ	EPE033BT	UV770 TAPE RH+LH THICKNESS 3MM LOOM 220 L.1980 MM
SN03123-WZ	EPE034BG	UV770 TAPE RH+LH THICKNESS 3MM LOOM 250 L.2130 MM
SN03124-WZ	EPE035BF	UV770 TAPE RH+LH THICKNESS 3MM LOOM 310CM L.2330MM
SN03125-WZ	EPE036BB	UV770 TAPE RH+LH THICKNESS 3MM LOOM 330CM L.2530MM
SN03126-WZ	EPE037BK	UV770 TAPE RH+LH THICKNESS 3MM LOOM 380 L.2650MM
SN03127-WZ	900135	VAMATEX C201 TAPE W=2200MM, L=1955MM
SN03128-WZ	2798417/2798428	VAMATEX9000 PLUS TAPE THICKNESS 3MM 190CM L.2450MM
SN03129-WZ	2798418/2798429	VAMATEX9000 PLUS TAPE THICKNESS 3MM 210 L.2550MM
SN03130-WZ	2798419/2798430	VAMATEX9000 PLUS TAPE THICKNESS 3MM 230CM L.2650MM
SN03131-WZ	2798420/2798431	VAMATEX9000 PLUS TAPE THICKNESS 3MM 260 L.2800MM
SN03132-WZ	2798421/2798432	VAMATEX9000 PLUS TAPE THICKNESS 3MM 280CM L.2900MM
SN03133-WZ	2798422/2798433	VAMATEX9000 PLUS TAPE THICKNESS 3MM 300 L.3030MM
SN03134-WZ	2798423/2798434	VAMATEX9000 PLUS TAPE THICKNESS 3MM 320 L.3130MM
SN03135-WZ	2798424/2798435	VAMATEX9000 PLUS TAPE THICKNESS 3MM 340 L.3230MM
SN03136-WZ	2798425/2798436	VAMATEX9000 PLUS TAPE THICKNESS 3MM 360 L.3330MM
SN03137-WZ	2798426/2798437	VAMATEX9000 PLUS TAPE THICKNESS 3MM 380 L.3430MM
SN03138-WZ	2798506	VAMATEX9000 PLUS TAPE THICKNESS 4MM 190 L.2450MM
SN03139-WZ	2798508	VAMATEX9000 PLUS TAPE THICKNESS 4MM 210 L.2550MM
SN03140-WZ	2798510	VAMATEX9000 PLUS TAPE THICKNESS 4MM 230 L.2650MM
SN03141-WZ	2798512	VAMATEX9000 PLUS TAPE THICKNESS 4MM 260 L.2800MM
SN03142-WZ	2798514	VAMATEX9000 PLUS TAPE THICKNESS 4MM 280 2900MM
SN03143-WZ	2798516	VAMATEX9000 PLUS TAPE THICKNESS 4MM 300 L.3030
SN03144-WZ	2798518	VAMATEX9000 PLUS TAPE THICKNESS 4MM 320 L.3130MM
SN03145-WZ	2798520	VAMATEX9000 PLUS TAPE THICKNESS 4MM 340 L.3230MM
SN03146-WZ	2798522	VAMATEX9000 PLUS TAPE THICKNESS 4MM 360 L.3330MM
SN03147-WZ	2798524	VAMATEX9000 PLUS TAPE THICKNESS 4MM 380 L.3430MM