



Weaving Accessories

COMMUNICATION / INNOVATION / COOPERATION

COMPANY PROFILE



Sino Textile

Sino Textile Machinery is specialized in weaving machinery spare parts. With more than 20 years of experience in textile industry, we can deliver textile machinery spare parts meeting the right demand on both quality and price. Under the joint efforts of our members, we have now grown up to be the most integrated supplier in China to offer weaving machines and loom spare parts.

We are providing—

Rapier loom spare parts: including rapier gripper, driving sprocket wheel, gripper opener/releaser, rapier tape, guide hook, guide rail.

Jacquard spare parts: including jacquard wire heddle, spring, comber board, harness cord, harness assembly, pulley wheel, module/solenoid, cable, controller.

Common replacement parts: including weft feeder/accumulator and the relevant parts, weft sensor, electronic weft selector, drop wire, leno selvedge device, heald wire, warp stop motion, tuck in device, cutter and blade, temple cylinder, proximity switch and sensor, circuit panel, electromagnet coil, encoder and motor, heald frame, membrane switch and touch screen, weft feeler, warp beam, clutch and brake, weaving reed and etc.

Dobby spare parts: for Staubli doobby and Chinese brand doobby.

According to brand, we are offering parts for: Picanol, Vamatex, Sulzer, Chinese loom, Somet, Dornier, Iro & Roj, Itema, Muller, Panter, Toyota, Tsudakoma, Van De Wiele, Bonas, Gross, Staubli and etc.

Add: No.9, 10th Street, HEDA,
Hangzhou, Zhejiang, China

Mob: 86-18058173515

Mail: merlin@sintotextilemachinery.com

申豪.范德维尔地毯.丝绒配件系列 SCHONHERR VDW Carpet.Velvet Spare Parts



申豪地毯送剑. SCHONHERR
Sending Gripper .ALPHA300 320



申豪地毯送剑. SCHONHERR
Receiving Gripper .ALPHA300 320

A001

B001



A002



B002



A003



A004



A005



A006



A007



B003



B004



B005



B006



B007



申豪地毯送剑.SCHONHERR
Sending Gripper .ALPHA360 400



申豪地毯送剑. SCHONHERR
Receiving Gripper .ALPHA360 400

A001

B001

A002



B002



A003



A004



A005



A006



A007



A008



B003



B004



B005



B006



B007



B008



B009



申豪地毯送剑. SCHONHERR
Sending Gripper .ALPHA 400-II



申豪地毯送剑. SCHONHERR
Receiving Gripper .ALPHA 400-II

A001

B001

A002



B002



A003



A004



A005



A006



B003



B004



B005



B006



B007

申豪.范德维尔地毯.丝绒配件系列 SCHONHERR VDW Carpet.Velvet Spare Parts



范德威尔送剑 (地毯)

Sending Gripper. CRM



范德威尔接剑 (地毯)

Receiving Gripper. CRM



A001

B001

A002

B002



A003 A004 A005 A006

B003 B004 B005 B006



范德威尔送剑 (地毯)

Sending Gripper. USX



范德威尔接剑 (地毯)

Receiving Gripper. USX



A001

B001

A002

B002



A003 A004 A005 A006 A007 A008

B003 B004 B005 B006 B007 B008 B009



范德威尔送剑 (地毯)

Sending Gripper. CRP



范德威尔接剑 (地毯)

Receiving Gripper. CRP



A001

B001

A002

B002



A003 A004 A005 A006 A007 A008

B003 B004 B005 B006 B007 B008 B009

申豪.范德维尔地毯.丝绒配件系列 SCHONHERR VDW Carpet.Velvet Spare Parts



CRT



CRX

范德威尔送剑 (地毯)
Sending Gripper. CRT CRX



CRT



CRX

范德威尔送剑 (地毯)
Sending Gripper. CRT CRX



范德威尔送剑 (地毯) Axminster
Sending Gripper. MAX63



范德威尔送剑 (地毯) Axminster
Receiving Gripper. MAX63

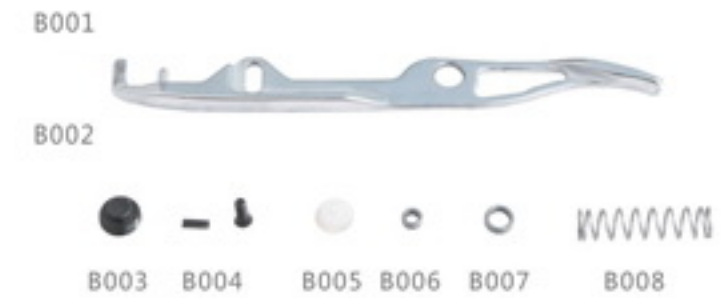

范德威尔送剑 (丝绒)
Sending Gripper(Velvet). MPS VMM VME VTR



范德威尔接剑 (丝绒)
Receiving Gripper(Velvet). MPS VMM VME VTR



申豪.范德维尔地毯.丝绒配件系列 SCHONHERR VDW Carpet.Velvet Spare Parts

高速阿克明斯特碳纤剑带 Axminster Carbon Tape



织布机门幅 Loom Space	剑杆带长度 Tape Length	备注 Remarks
	L3400mm	



高速阿克明斯特绒经载纱器 Axminster Pile Warp Holder



织布机门幅 Loom Space	载纱器长度 Holder Length	备注 Remarks
	16 Lengths	

16个长度

阿克明斯特剑带 Axminster Tape



中国产阿克明斯特剑头



Sending Gripper



Receiving Gripper



句内丝绒左剑杆 NT.GUNNE-LHS-1



句内丝绒右剑杆 NT.GUNNE-RHS-2



句内丝绒左剑杆 NT.GUNNE-LHS-3



句内丝绒右剑杆 NT.GUNNE-RHS-4



句塞克.送剑. Gusken
Velvet Sending Gripper



句塞克.接剑. Gusken
Velvet Receiving Gripper



句内.丝绒剑头. Gunne
Velvet Gripper



句内.丝绒剑头. Gunne
Velvet Gripper

申豪.范德维尔地毯.丝绒配件系列 SCHONHERR VDW Carpet.Velvet Spare Parts

范德维尔丝绒剑杆 NT.VTR VMM VME-Carbon Tape With Head



范德维尔丝绒剑杆 NT.MPS-Carbon Tape With Head



句内丝绒剑杆 NT.OLD1-Carbon Tape With Head



句内丝绒剑杆 NT.OLD2-Carbon Tape With Head



句塞克丝绒右剑杆 NT.GUSKEN-RHS



句塞克丝绒左剑杆 NT.GUSKEN-LHS

申豪.范德维尔地毯.丝绒配件系列 SCHONHERR VDW Carpet.Velvet Spare Parts

申豪地毯剑杆 NT.ALPHA300 320-Carbon Tape Complete



申豪地毯剑杆 NT.ALPHA360 400-Carbon Tape Complete

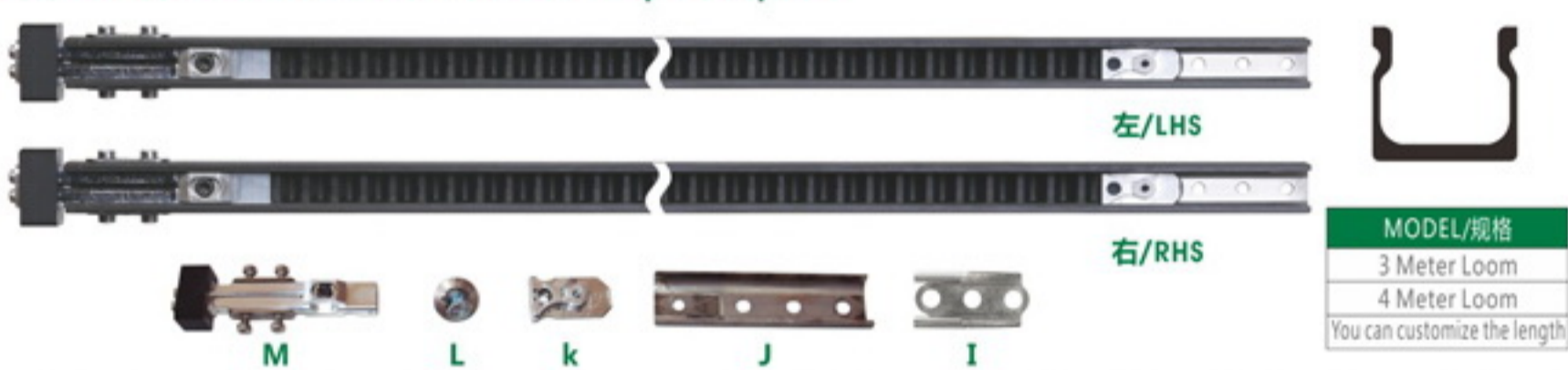

范德维尔地毯剑杆 NT.CRT CRM CRX USX-Carbon Tape Complete

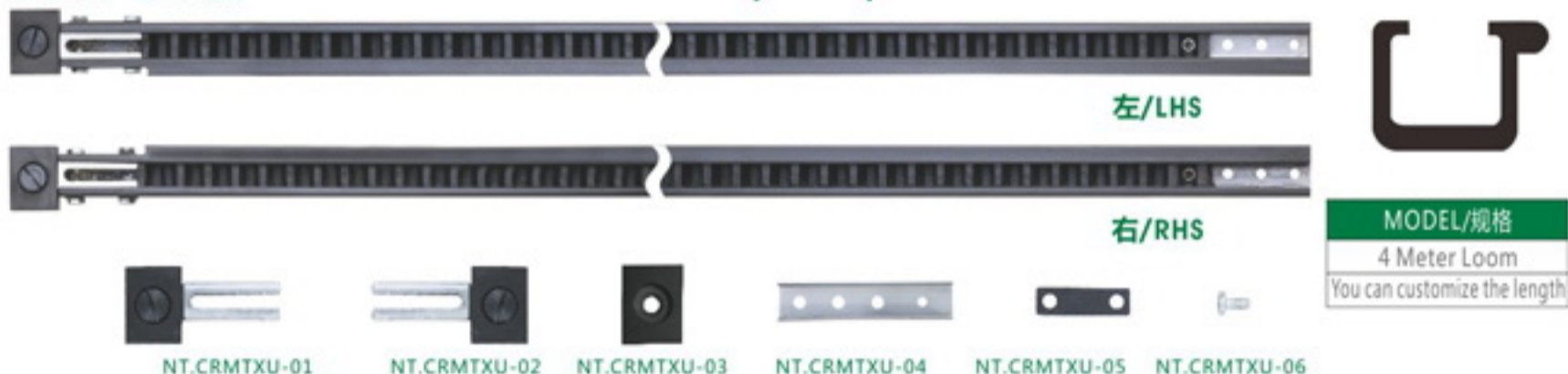

范德维尔地毯剑杆 NT.CRP Carbon Tape Complete

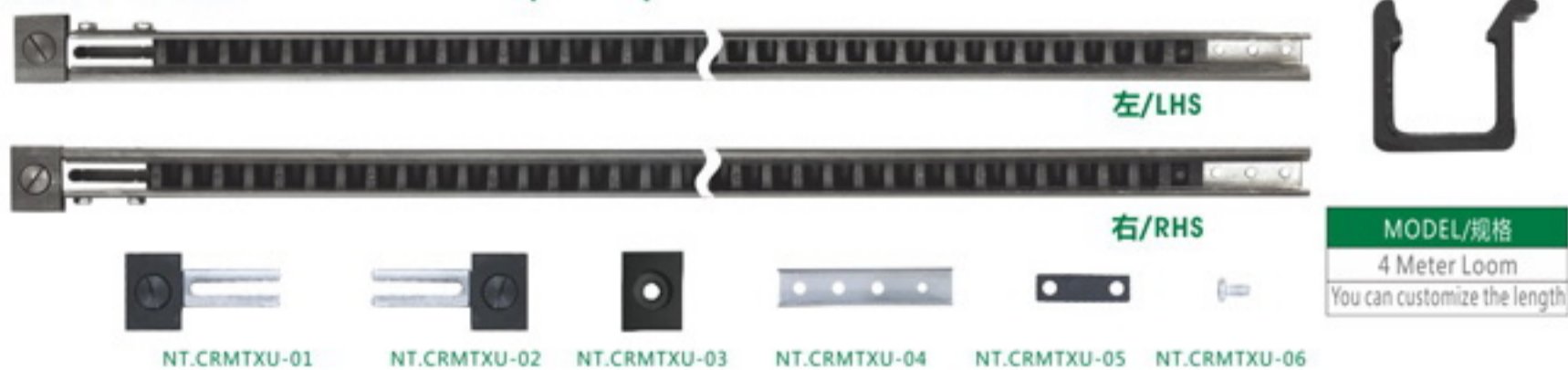

申豪地毯左剑杆 NT.ALPHA 400II-LHS

申豪地毯右剑杆 NT.ALPHA400II-RHS

申豪.范德维尔地毯.丝绒配件系列 SCHONHERR VDW Carpet.Velvet Spare Parts

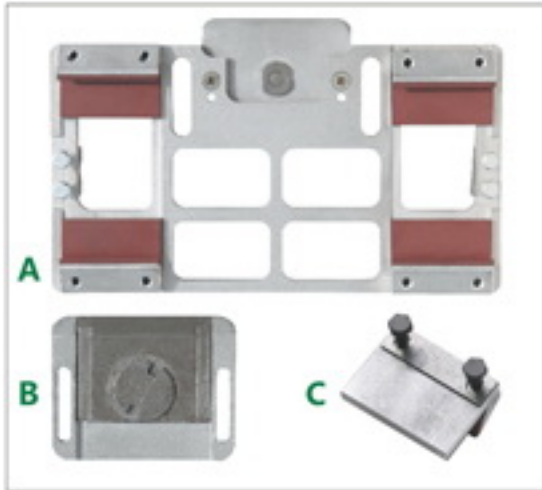

NT.W01

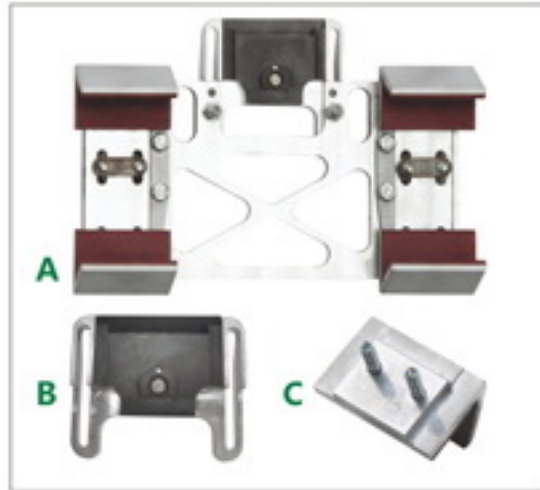

NT.W02

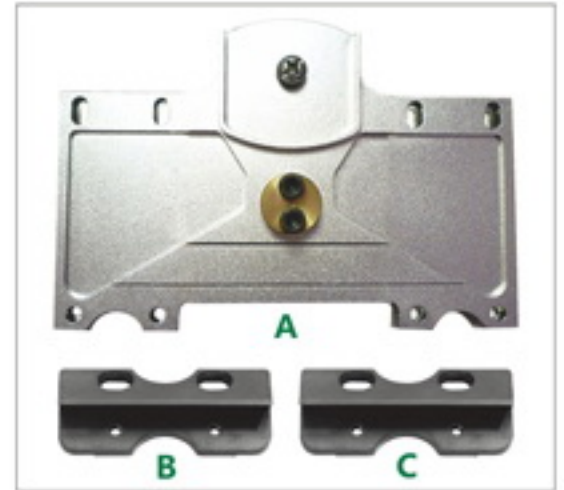

NT.W03 Alpha300/320

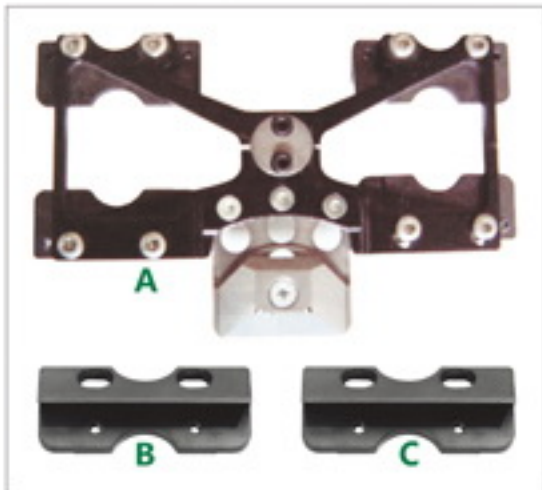

NT.W04 Alpha360/400

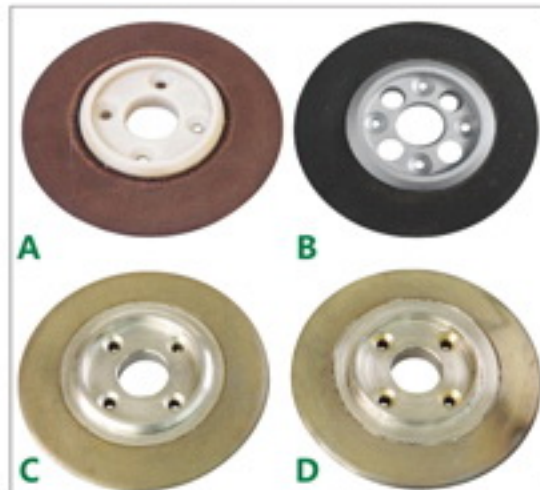

NT.W05

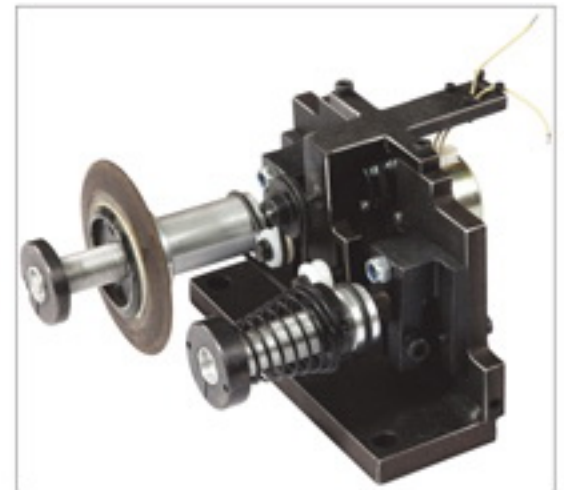

NT.W06



NT.W07

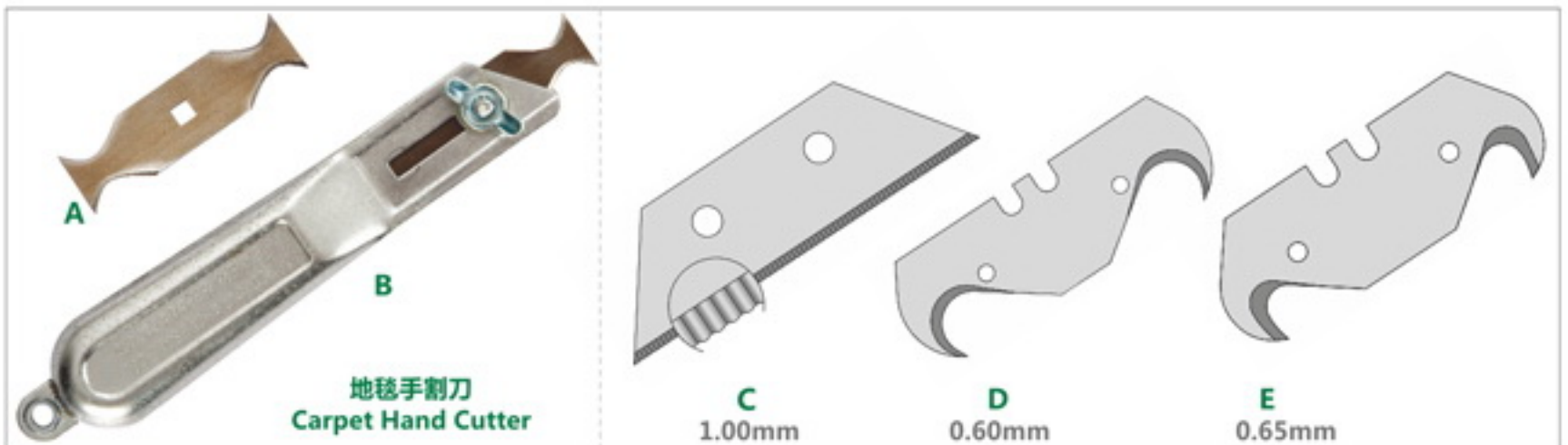

NT.W08

申豪.范德维尔地毯.丝绒配件系列 SCHONHERR VDW Carpet.Velvet Spare Parts



NT.W09



NT.W10



NT.W11



NT.W12



NT.W13



NT.W14



NT.W15



NT.W16



NT.W17



NT.W18



NT.W19



NT.W20



NT.W21



NT.W22



NT.W23



NT.W24



NT.W25



NT.W26



NT.W27



NT.W28



NT.W29



阿尔法Alpha360/400

NT.W30



阿尔法Alpha 360/400

NT.W31

申豪.范德维尔地毯.丝绒配件系列 SCHONHERR VDW Carpet.Velvet Spare Parts

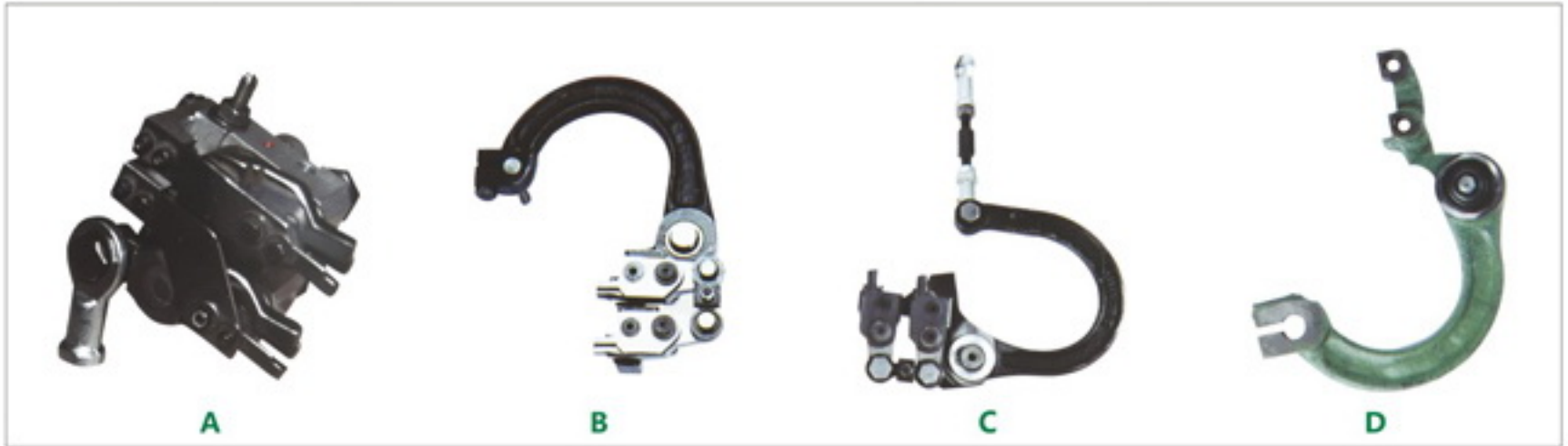

NT.W32

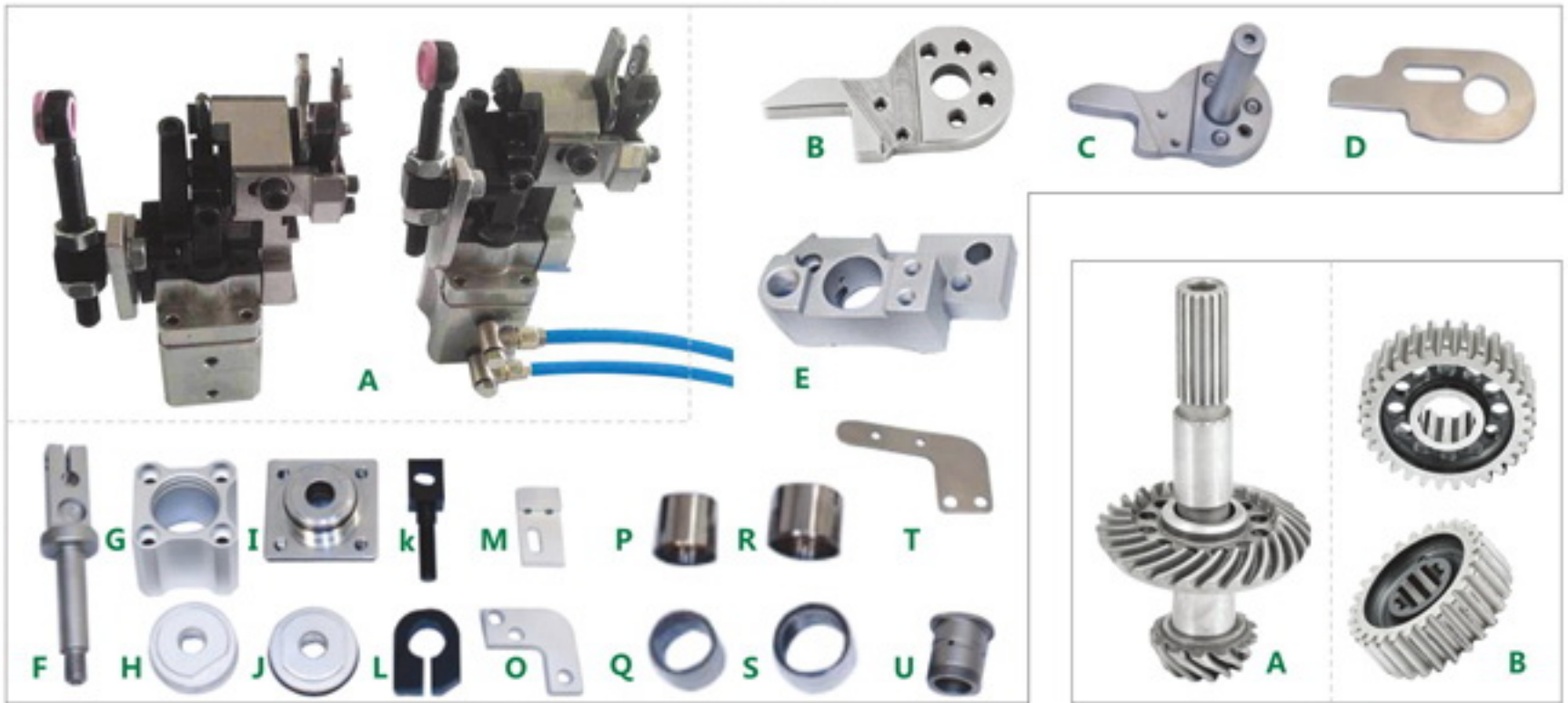

NT.W33



NT.W34



NT.W35



NT.W36



NT.W37



NT.W38



NT.W39



NT.W40



NT.W41

申豪.范德维尔地毯.丝绒配件系列 SCHONHERR VDW Carpet.Velvet Spare Parts



NT.W42



NT.W43



NT.W44



NT.W45



NT.W46



NT.W47

申豪.范德维尔地毯.丝绒配件系列 SCHONHERR VDW Carpet.Velvet Spare Parts

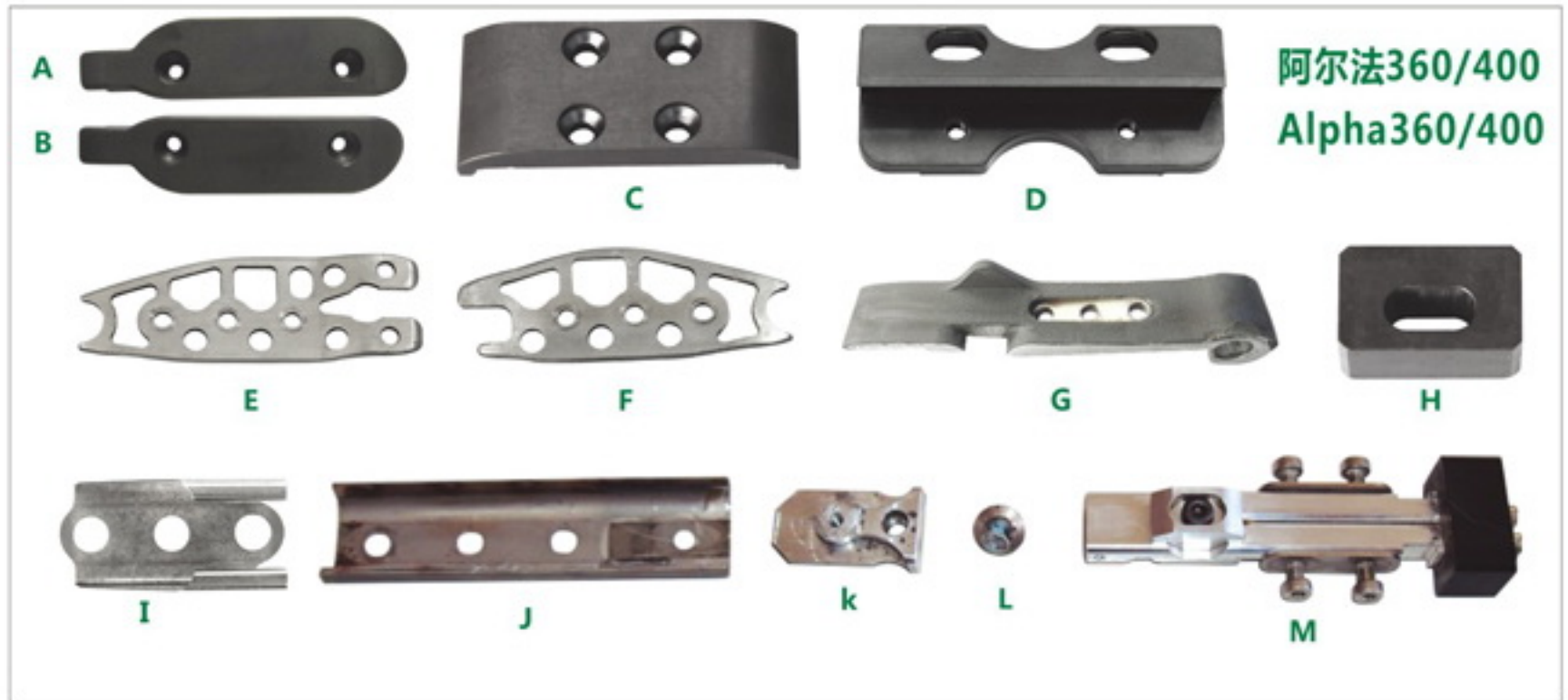

NT.W48

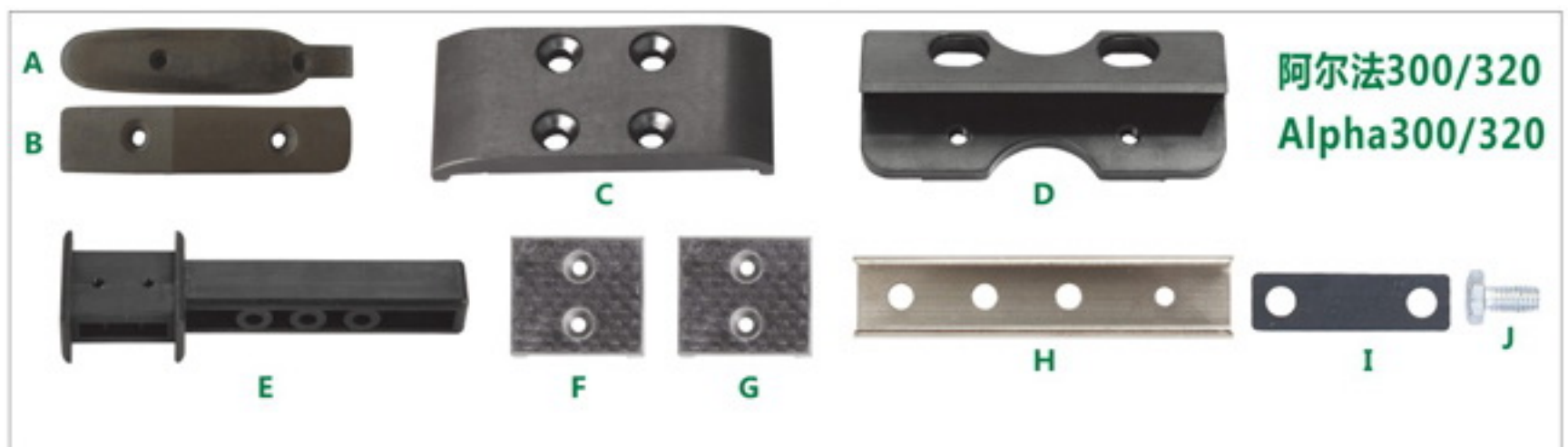

NT.W49

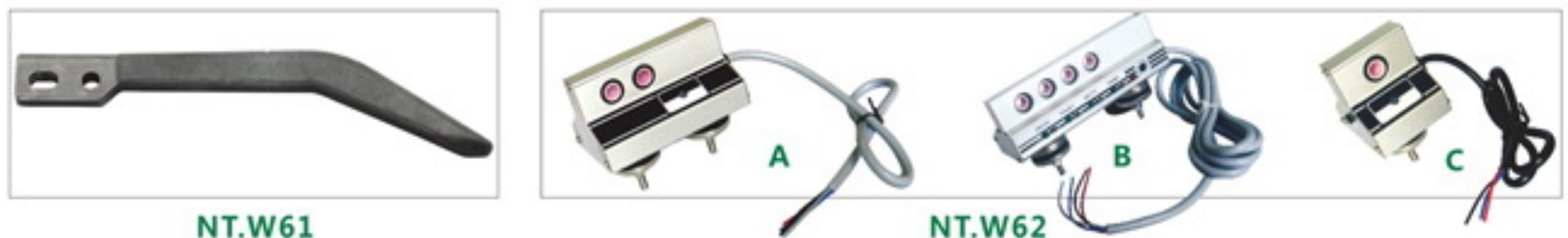

申豪.范德维尔地毯.丝绒配件系列 SCHONHERR VDW Carpet.Velvet Spare Parts



NT.W63

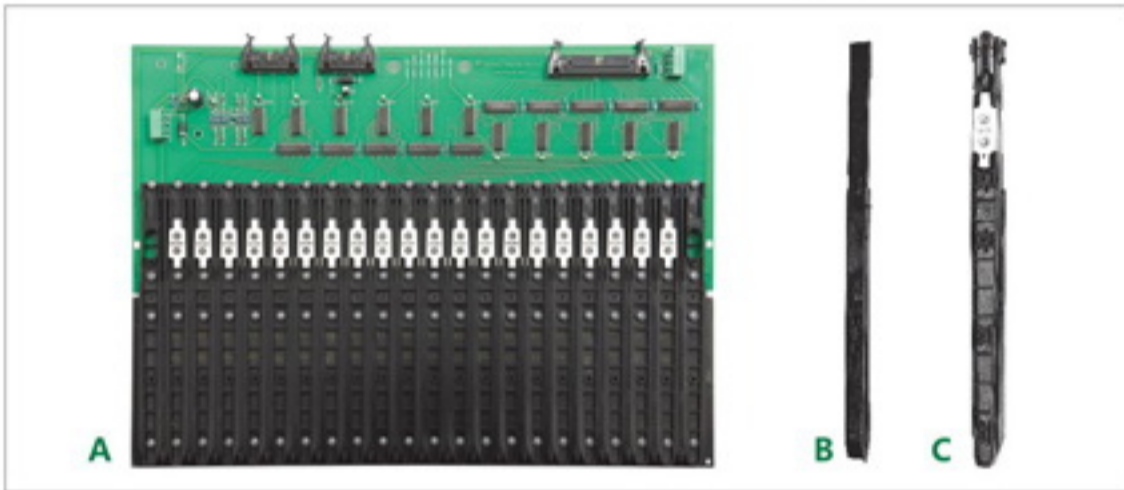

NT.W64

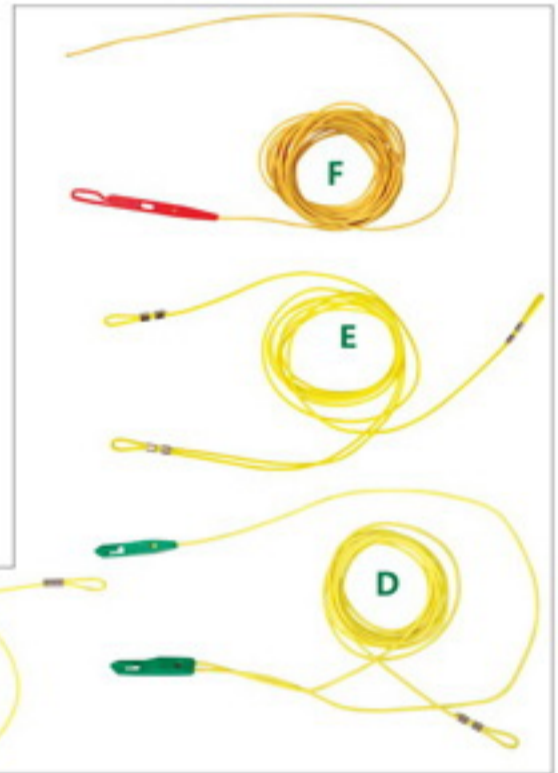

NT.W65

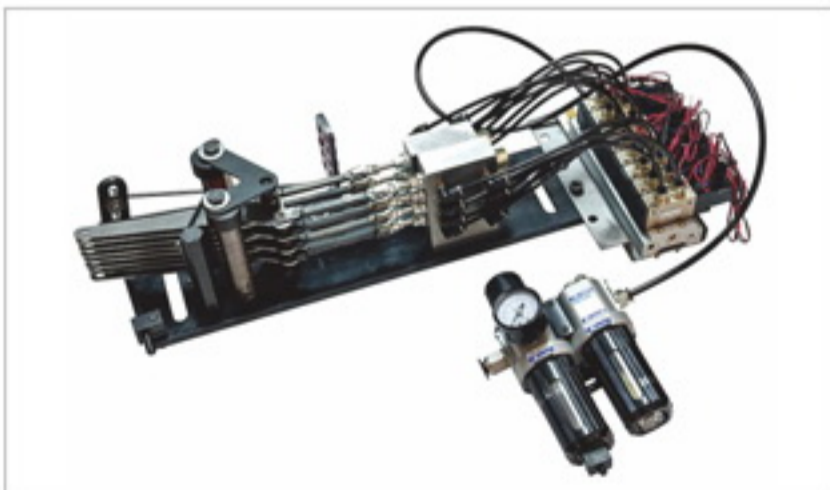

NT.W66

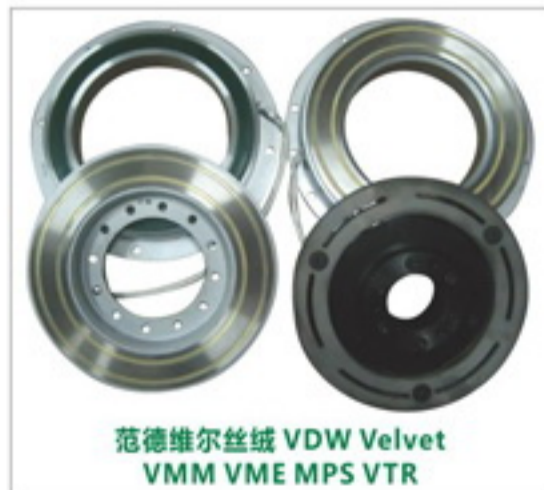

范德维尔丝绒 VDW Velvet
VMM VME MPS VTR

NT.W67



NT.W68



申豪/范德维尔地毯.丝绒停经条 SCHONHERR/VDW Carpet.Velvet Warp Stop Strip

- L1810mm
- L1882mm
- L1890mm
- L2030mm
- L2298mm
- L2400mm
- L4090mm

NT.W69

申豪.范德维尔地毯.丝绒配件系列 SCHONHERR VDW Carpet.Velvet Spare Parts



NT.W70



NT.W71



NT.W72



NT.W73

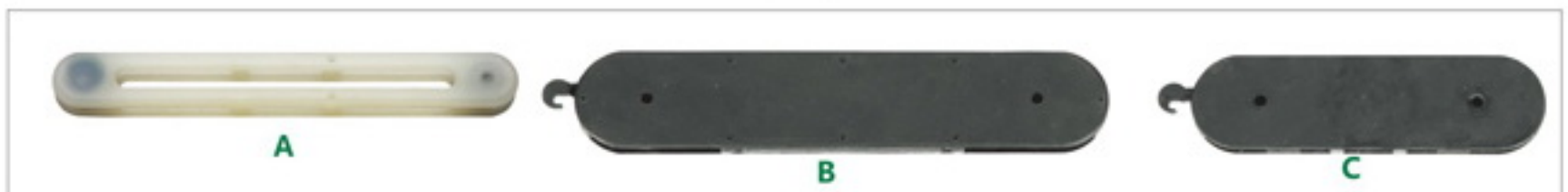

NT.W74



NT.W75



NT.W76



NT.W77

苏拉.S400配件系列 Saurer.S400 Spare Parts

瑞士苏拉剑杆机配件系列

适用机型：S400

网站内容每个月更新，目录内容每两年更新

更多内容，请访问网站 www.sinotextilemachinery.com

Swiss Saurer Rapier Loom Parts

Model: S400

Our Website updates every month, and printed catalog updates every two years

For more, please follow our website:

www.sinotextilemachinery.com



Item	Saurer Part No.	Description
1	720332	CLUTCH
2	720318	INDUCTOR
3	720327/720333	INDUCTOR
4	720325	ARMATURE
5		SPRING PLATE

苏拉.S400配件系列 Saurer.S400 Spare Parts

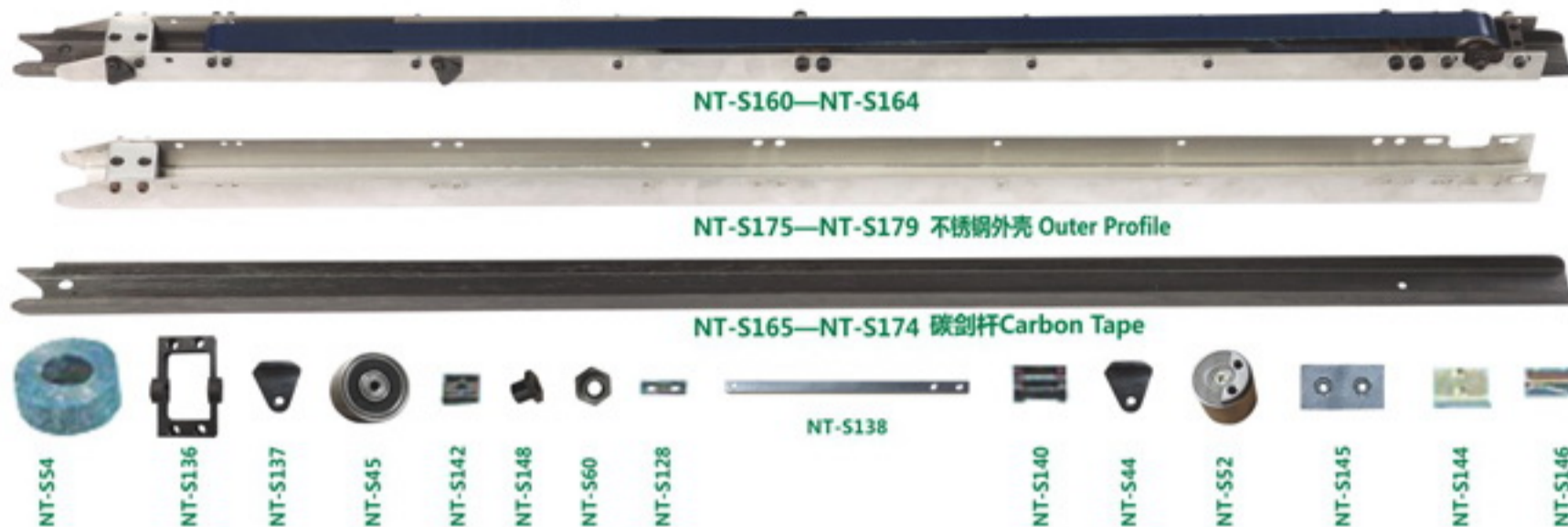

门幅Loom Width	碳剑杆Carbon Tape	不锈钢外壳 Outer Profile	备注
H185	830mm	805mm	 NT-S138
H205	874mm	848mm	
H225	934mm	909mm	
H245	1020mm	959mm	
H265	1075mm	1010mm	

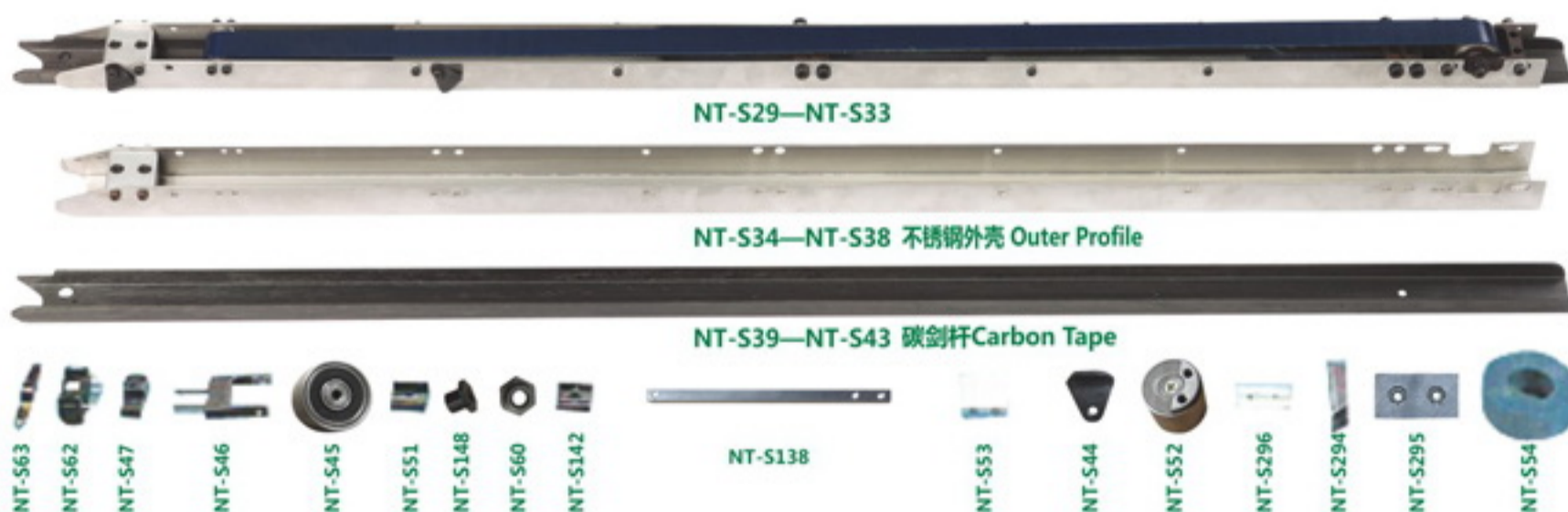

门幅Loom Width	碳剑杆Carbon Tape	不锈钢外壳 Outer Profile	备注
H185	830mm	789mm	 NT-S138
H205	874mm	833mm	
H225	934mm	893mm	
H245	1020mm	939mm	
H265	1075mm	994mm	

苏拉.S400配件系列 Saurer.S400 Spare Parts

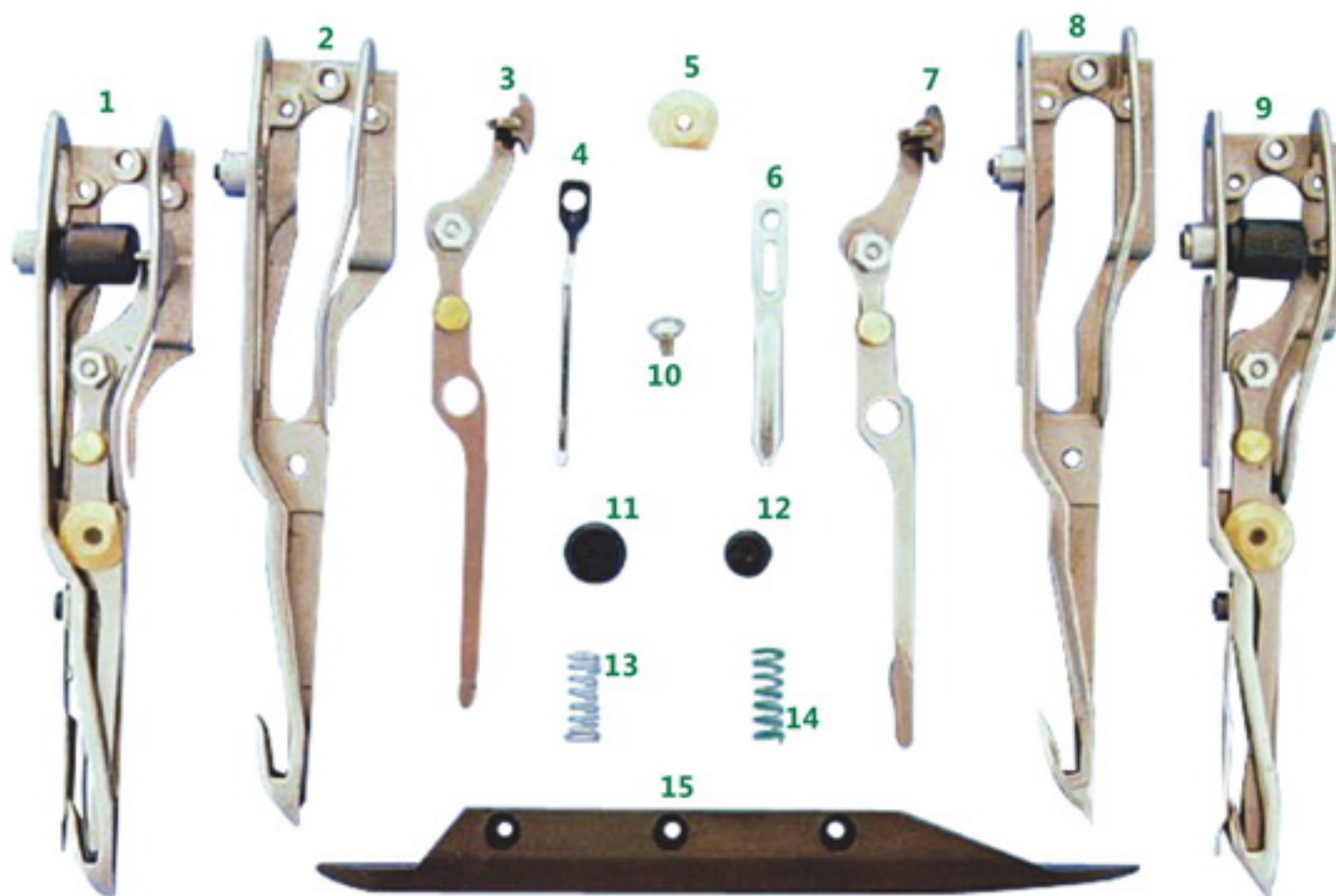

Item	Saurer Part No.	Description
1	847153	HOOK COMPLETE STANDARD
2	847153.1	HOOK SHELL STANDARD
3	844023	LEVER
4	844021	PINCER
5	847138	AXLE
6	844022	LATCH
7	846907	LEVER SERRATED
8	847127	HOOK SHELL SERRATED
9	847323	HOOK COMPLETE SERRATED
10	253774	ADJUSTING SCREW
11	845089	CAP-BIG
12	845088	CAP-SMALL
13	252369	SPRING
14	253002	SPRING-GREEN
15	844517	SLIDING PLATE

苏拉.S400配件系列 Saurer.S400 Spare Parts



Item	Saurer Part No.	Description
1	847151.1	HEAD SHELL
2	847151	HEAD COMPLETE STANDARD
3	847133	HEAD COMPLETE SERRATED
4	847140	MOVABLE BLADE
5	847134	MOVABLE BLADE SERRATED
6	843727	FIXED BLADE
7	847135	FIXED BLADE SERRATED
8	786032	O RING
9	841619	SMALL PLATE
10	847139	BUSH
11	845089	CAP-BIG
12	845088	CAP-SMALL
13	728041	SCREW FHC/90
14	253002	SPRING-GREEN
15	253003	SPRING-YELLOW
16	252368	SPRING-RED
17	844550	SLIDING PLATE

苏拉.S400配件系列 Saurer.S400 Spare Parts

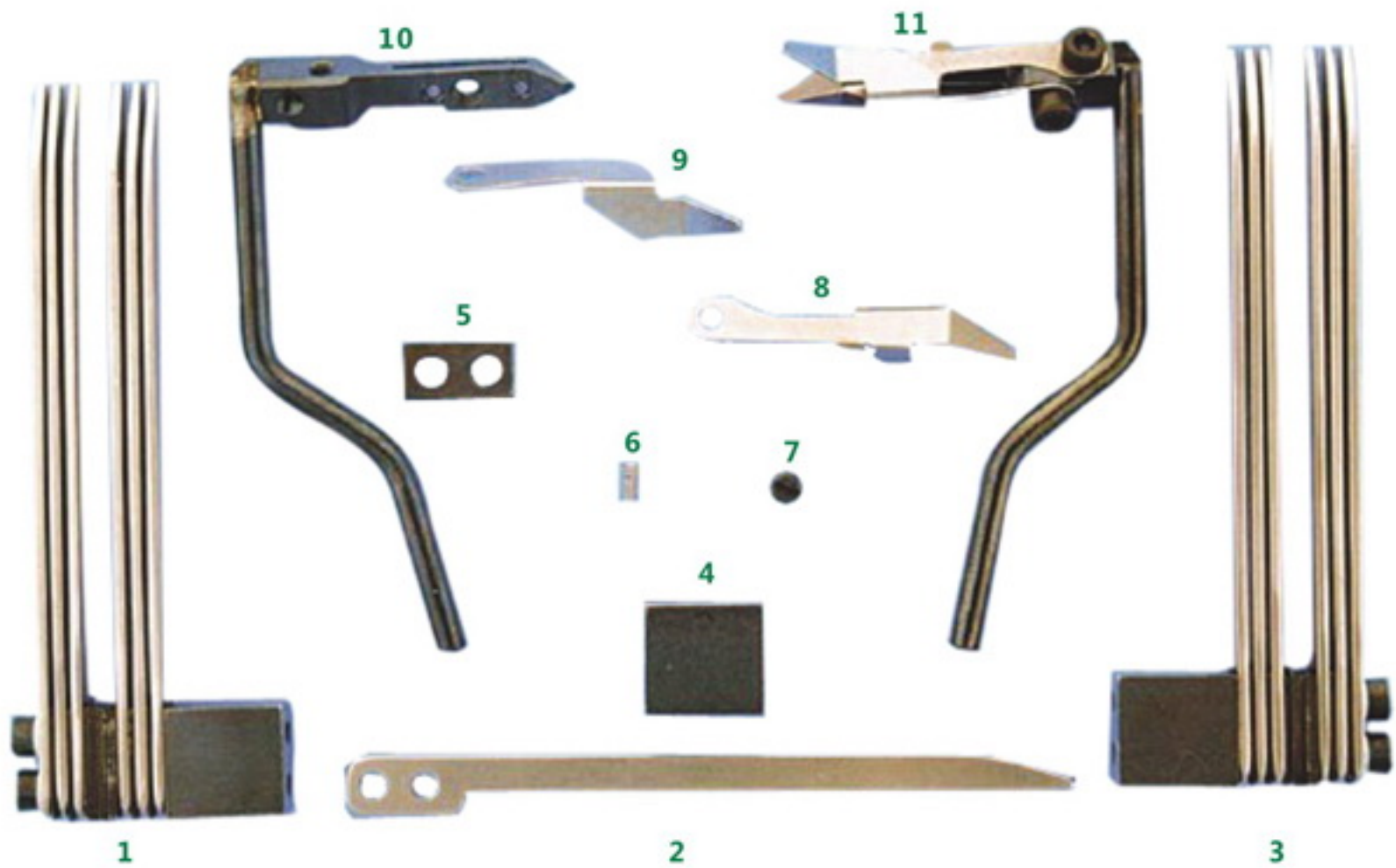

Item	Saurer Part No.	Description
1	844254	FALSE REED L.H.
2	842514	TOOTH
3	844352	FALSE REED R.H.
4	842513	PLATE
5	842512	INTERMEDIATE PLATE
6	250692	SPRING
7	250691	HOLLOW SCREW
8	847267	MOVABLE CLAMP
9	847115	FIXED CLAMP
10	847141.1	FORK SHELL
11	847141	FORK

苏拉.S400配件系列 Saurer.S400 Spare Parts

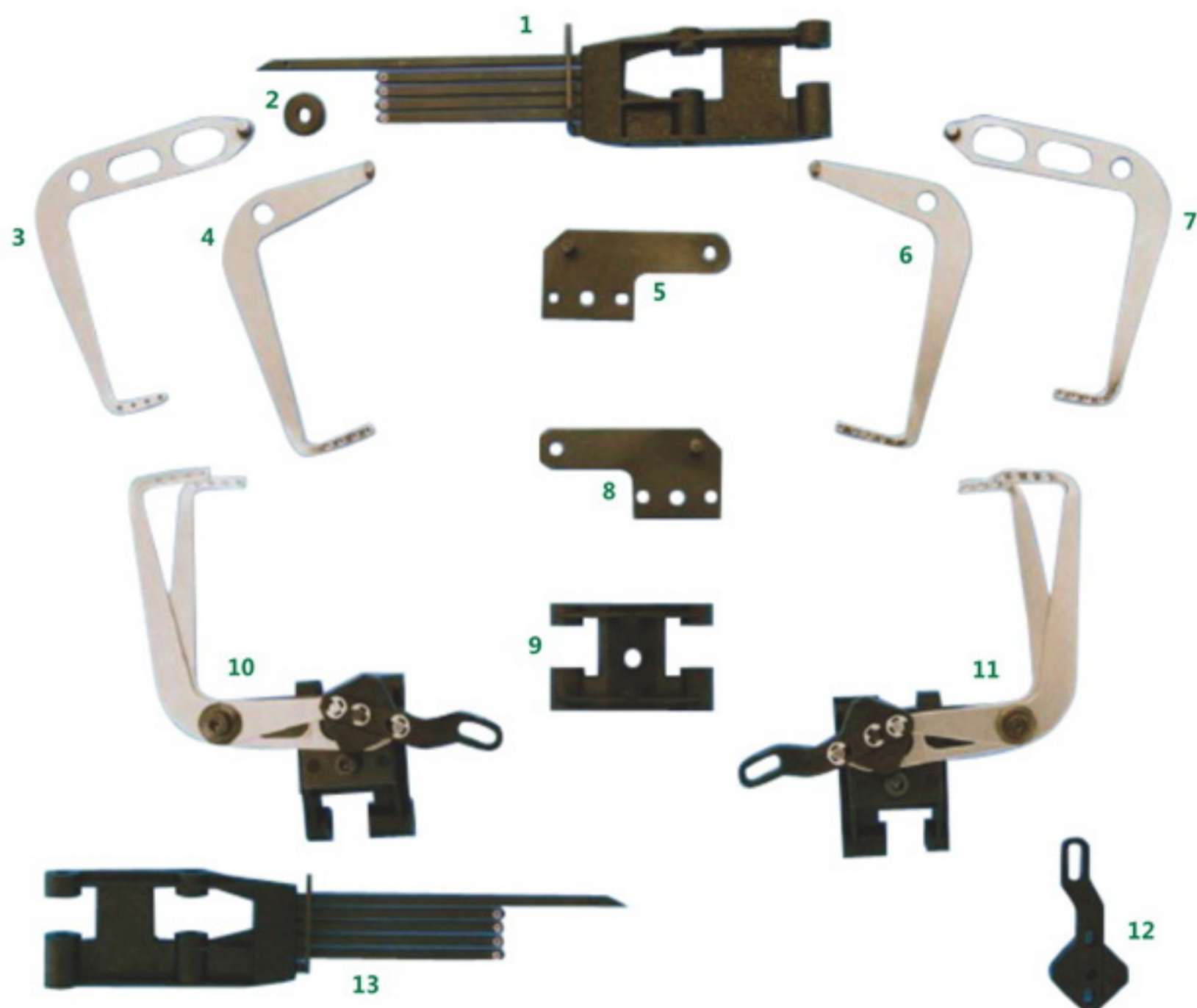

Item	Saurer Part No.	Description
1	845931	QUADRUPLE NEEDLE R.H.
2	847023	BEARING BUSH
3	845165	FINGER R.H.
4	845164	FINGER R.H.
5	845168	HOLDER R. H.
6	845166	FINGER L.H.
7	845167	FINGER L.H.
8	845169	HOLDER L.H.
9	845024	STIRRUP
10	601013	LENO COMPLETE R.H.
11	601014	LENO COMPLETE L.H.
12	844506	JACK
13	845932	QUADRUPLE NEEDLE L.H.

苏拉.S400配件系列 Saurer.S400 Spare Parts

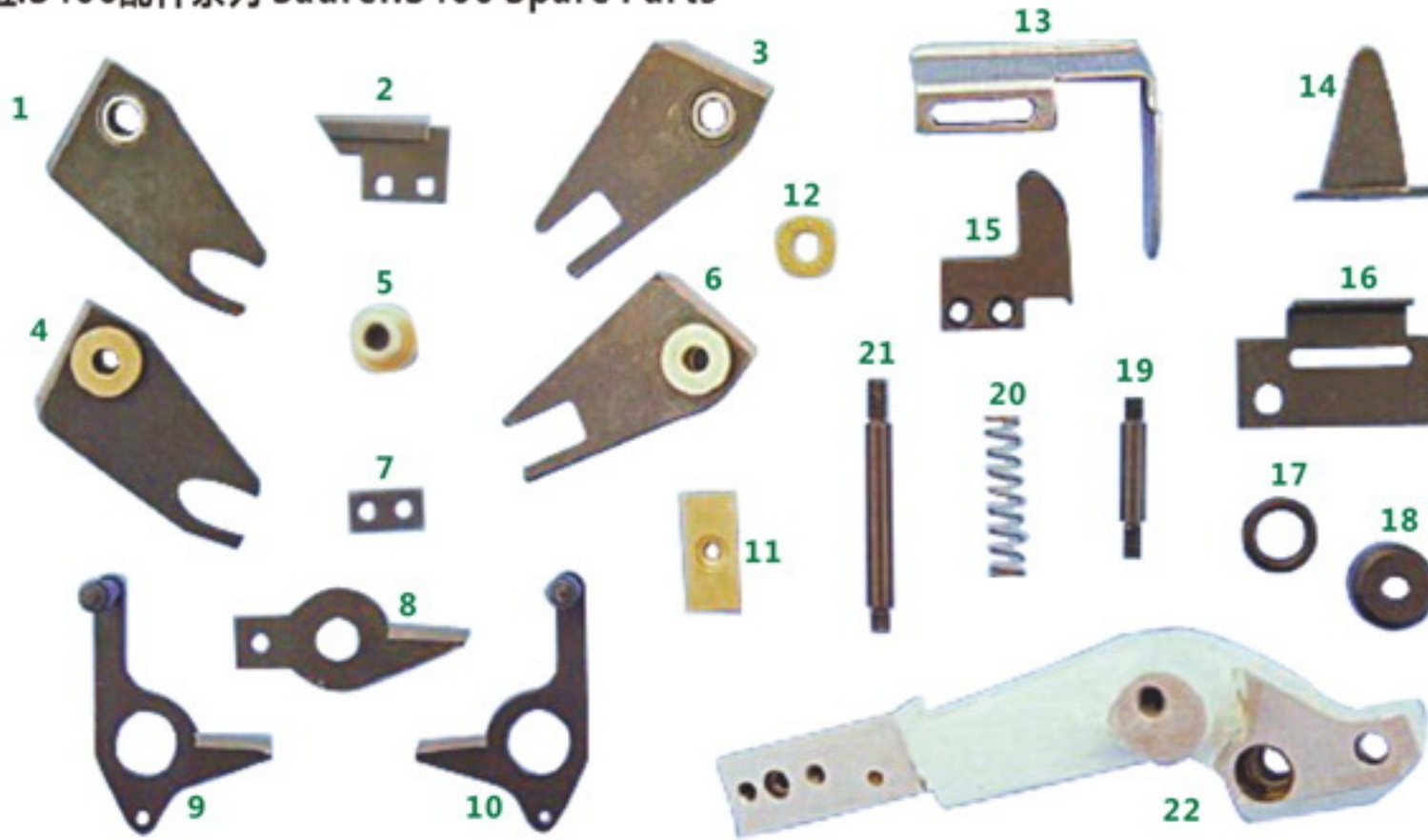

Item	Saurer Part No.	Description
1	842736	MOVABLE BLADE-BEARING
2	843732	FIXED BLADE
3	845107	MOVABLE BLADE-BEARING
4	842736.1	MOVABLE BLADE-BUSHING
5	848881	BUSH
6	845107.1	MOVABLE BLADE-BUSHING
7	845342	WEDGE
8	841368	FIXED BLADE
9	844656	MOVABLE BLADE R.H.
10	844990	MOVABLE BLADE L.H.
11	844108	SLIDING PLATE
12	700014	BEARING
13	844241	WEFT LOCKING DEVICE
14	844256	WEFT LOCKING DEVICE
15	844257	OUTER HOOK
16	842045	HOOK
17	452013	JOINT
18	842733	PROTECTOR
19	842734	AXLE
20	848087	PRESSURE SPRING
21	846650	AXLE
22	846919	CUTTER HOLDER

苏拉.S400配件系列 Saurer.S400 Spare Parts

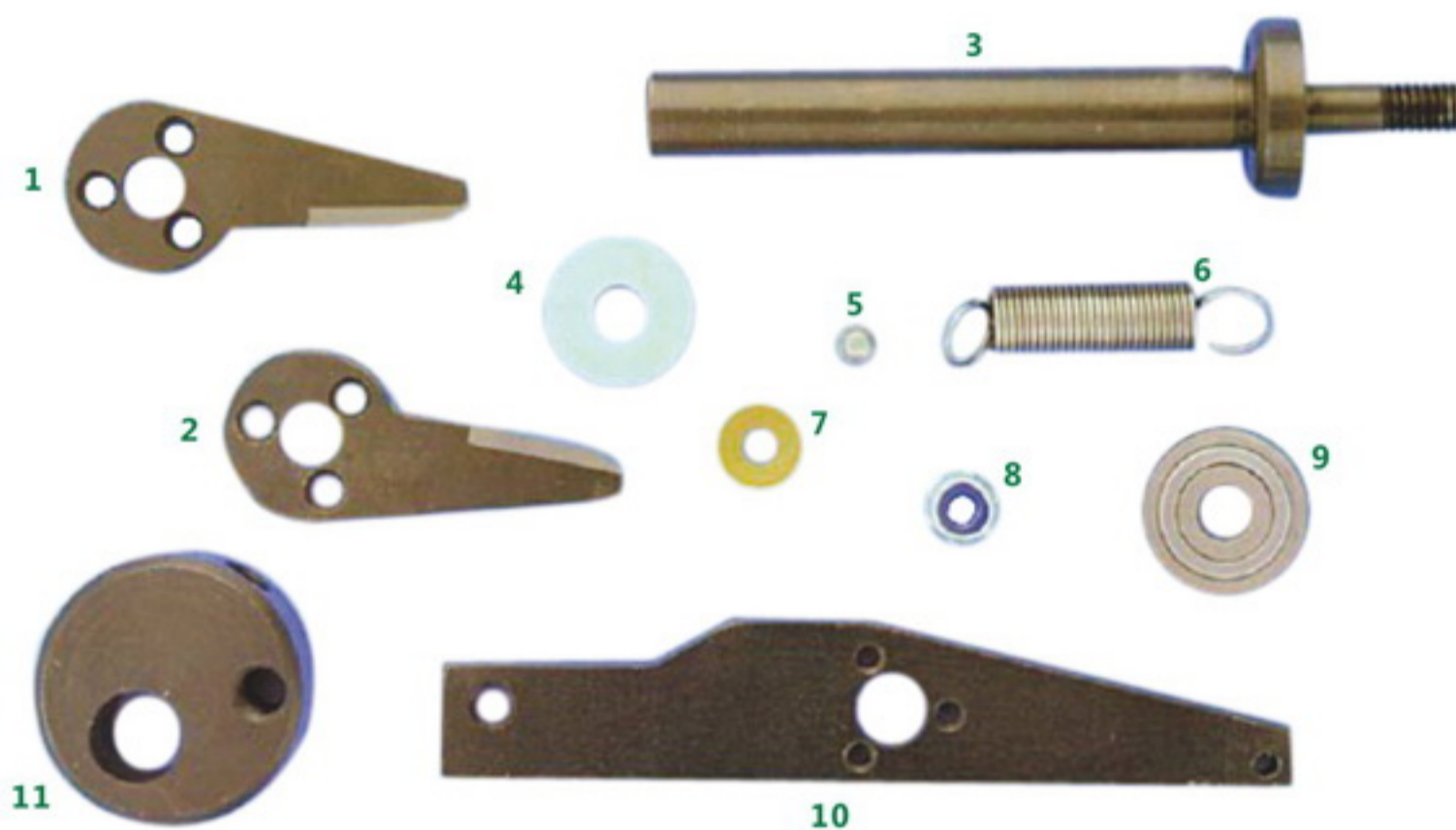

Item	Saurer Part No.	Description
1	500154	SCISSORS
2	500153	SCISSORS
3	841782	AXLE
4	841781	RING
5	250060	SCREW
6	251339	SPRING
7	142005	WASHER
8	117005	NUT
9	300006	BALL BEARING
10	841271	SCISSORS LEVER
11	841739	EXCENTRIC RING

苏拉.S400配件系列 Saurer.S400 Spare Parts

